

Chapter I Introduction

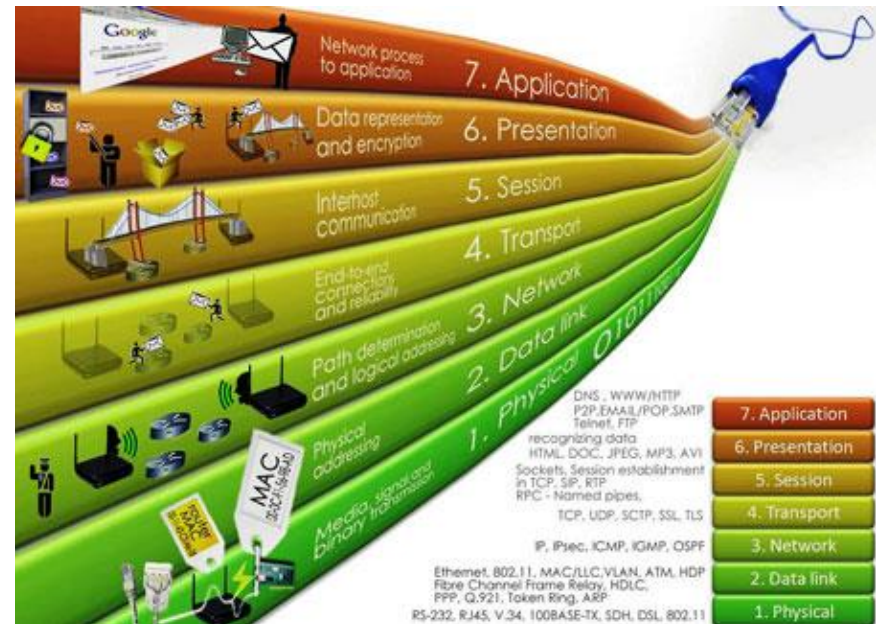

Introduction

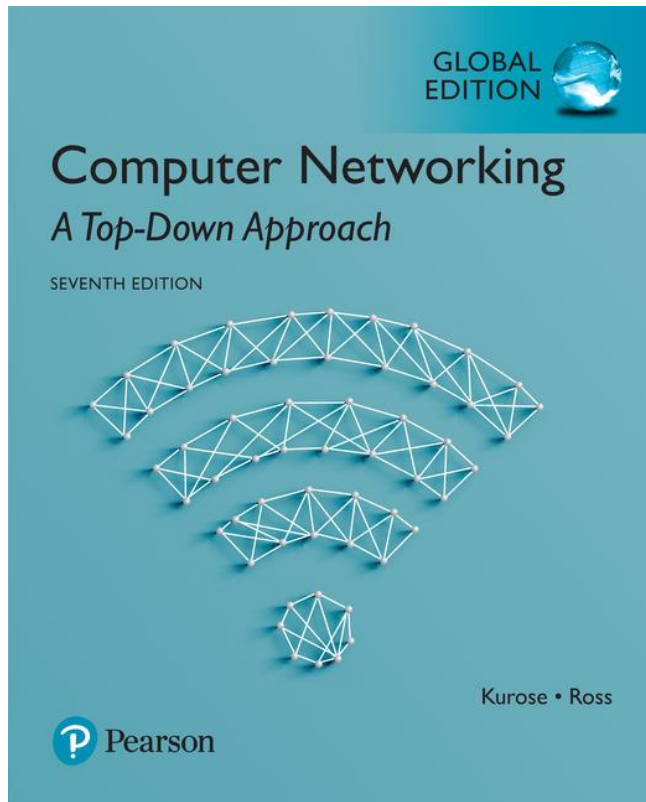

Prof. Sungwook Kim (김승욱)

AS building 903

Tel : 02) 705-8932

E-mail : swkim01@sogang.ac.kr



TA : Joonsu Ryu (류준수)

AS building 901

E-mail : sok54833@naver.com

Chapter 1: introduction

our goal:

- get “feel” and terminology
- more depth, detail *later* in course
- approach:
 - use Internet as example

overview:

- what’s the Internet?
- what’s a protocol?
- network edge; hosts, access net, physical media
- network core: packet/circuit switching, Internet structure
- performance: loss, delay, throughput
- protocol layers, service models
- history

Chapter 1: roadmap

1.1 *what is the Internet?*

1.2 network edge

- end systems, access networks, links

1.3 network core

- packet switching, circuit switching, network structure

1.4 delay, loss, throughput in networks

1.5 protocol layers, service models

1.6 history

What's the Internet: "nuts and bolts" view



- billions of connected computing devices:
 - hosts* = *end systems*
 - running *network apps*

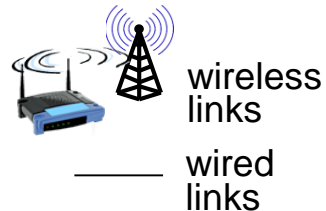

- communication links*
 - fiber, copper, radio, satellite
 - transmission rate: *bandwidth*



- packet switches*: forward packets (chunks of data)
 - routers* and *switches*

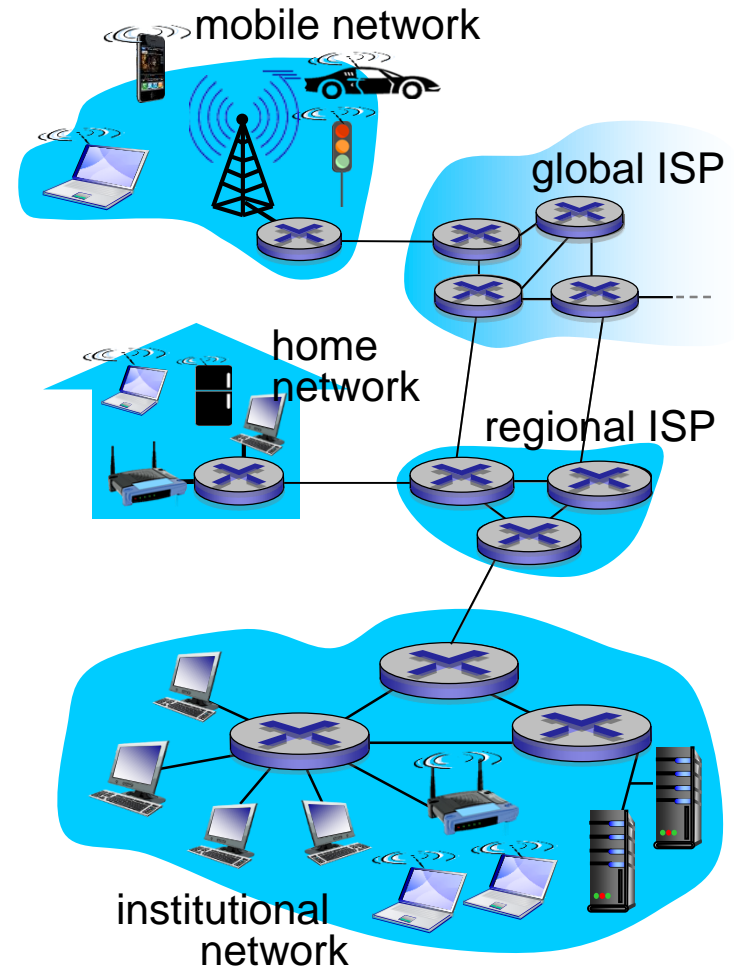

“Fun” Internet-connected devices



IP picture frame
<http://www.ceiva.com/>



Web-enabled toaster +
weather forecaster



Tweet-a-watt:
monitor energy use



Internet
refrigerator



Slingbox: watch,
control cable TV remotely



sensorized,
bed
mattress



Internet phones

What's the Internet: "nuts and bolts" view

- **Internet: "network of networks"**
 - Interconnected ISPs
- **protocols** control sending, receiving of messages
 - e.g., TCP, IP, HTTP, Skype, 802.11
- **Internet standards**
 - RFC: Request for comments
 - IETF: Internet Engineering Task Force

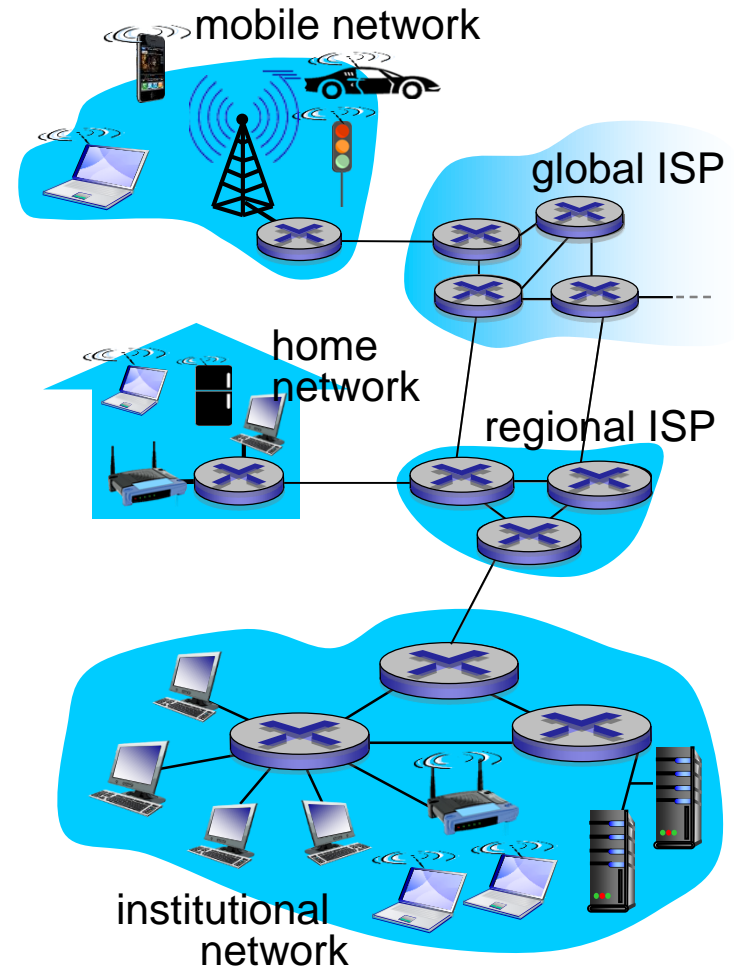

What's the Internet: a service view

- *infrastructure that provides services to applications:*
 - Web, VoIP, email, games, e-commerce, social nets, ...
- *provides programming interface to apps*
 - hooks that allow sending and receiving app programs to “connect” to Internet
 - provides service options, analogous to postal service

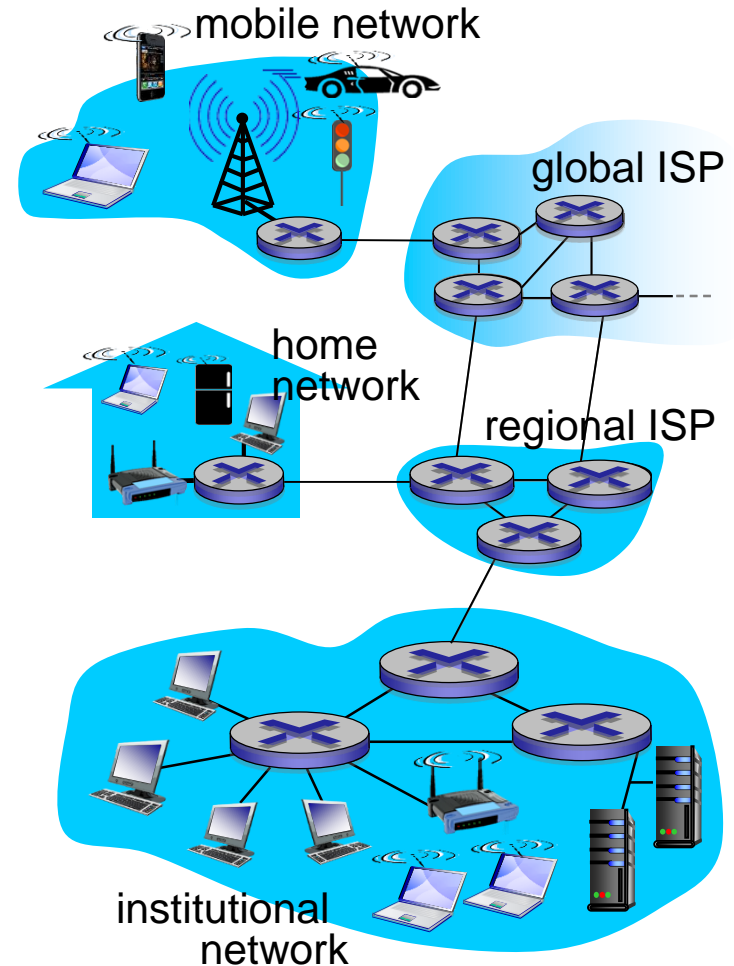

What's a protocol?

human protocols:

- “what's the time?”
- “I have a question”
- introductions

... specific messages sent

... specific actions taken
when messages received,
or other events

network protocols:

- machines rather than humans
- all communication activity in Internet governed by protocols

protocols define format, order of messages sent and received among network entities, and actions taken on message transmission, receipt

What's a protocol?

a human protocol and a computer network protocol:

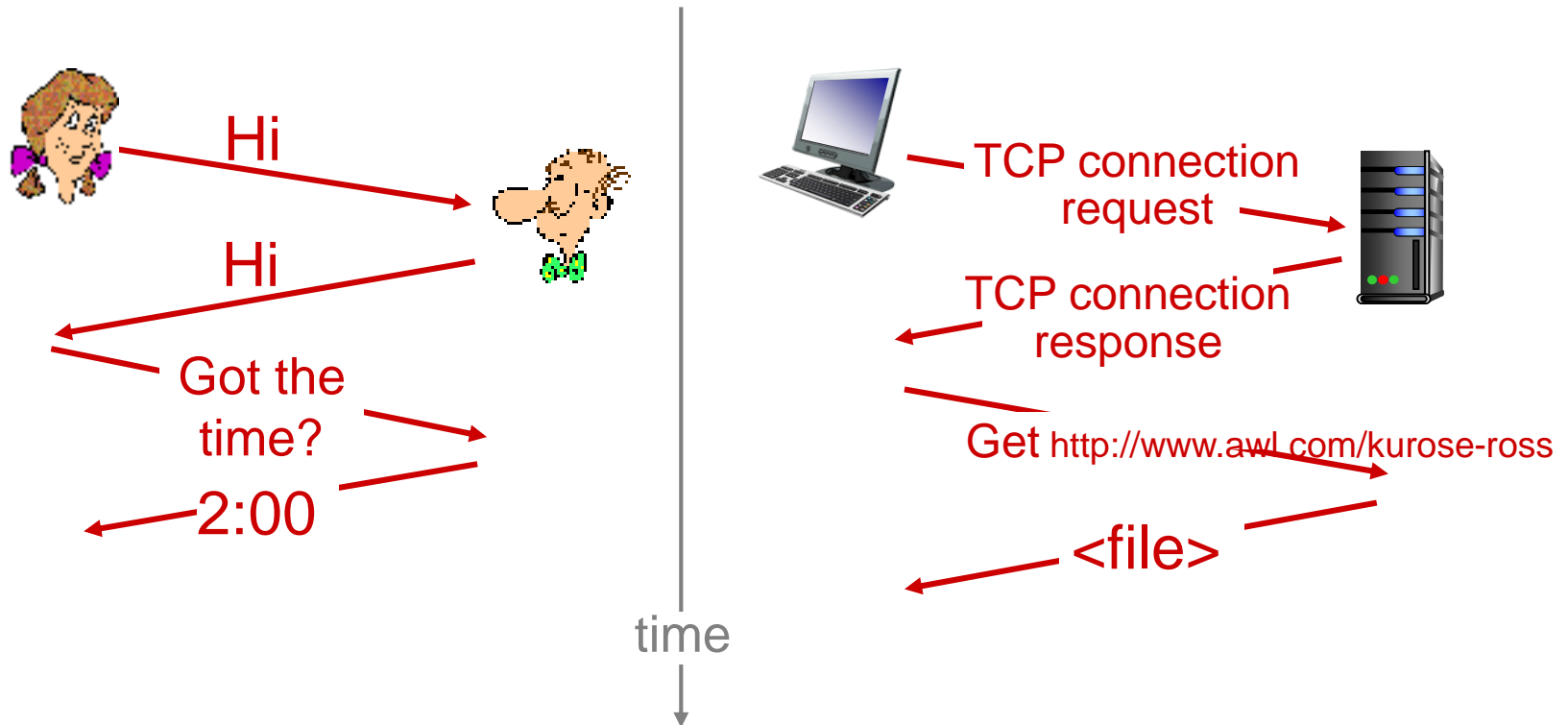

Q: other human protocols?

Chapter 1: roadmap

1.1 what *is* the Internet?

1.2 network edge

- end systems, access networks, links

1.3 network core

- packet switching, circuit switching, network structure

1.4 delay, loss, throughput in networks

1.5 protocol layers, service models

1.6 history

A closer look at network structure:

- **network edge:**
 - hosts: clients and servers
 - servers often in data centers
- **access networks, physical media:** wired, wireless communication links
- **network core:**
 - interconnected routers
 - network of networks

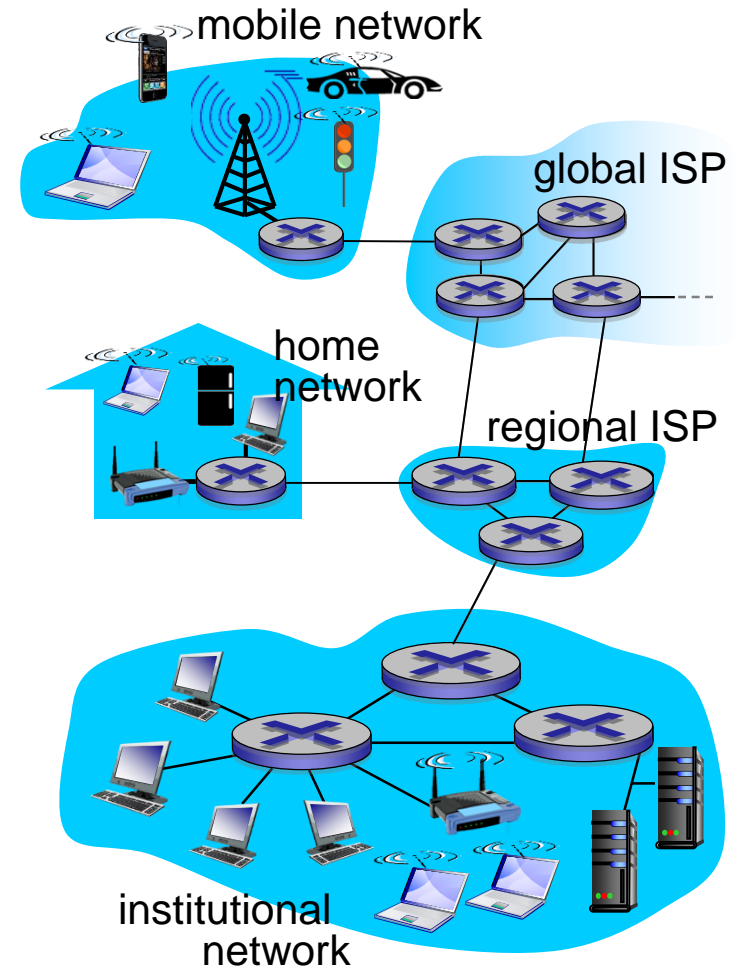

Access networks and physical media

Q: How to connect end systems to edge router?

- residential access nets
- institutional access networks (school, company)
- mobile access networks

keep in mind:

- bandwidth (bits per second) of access network?
- shared or dedicated?

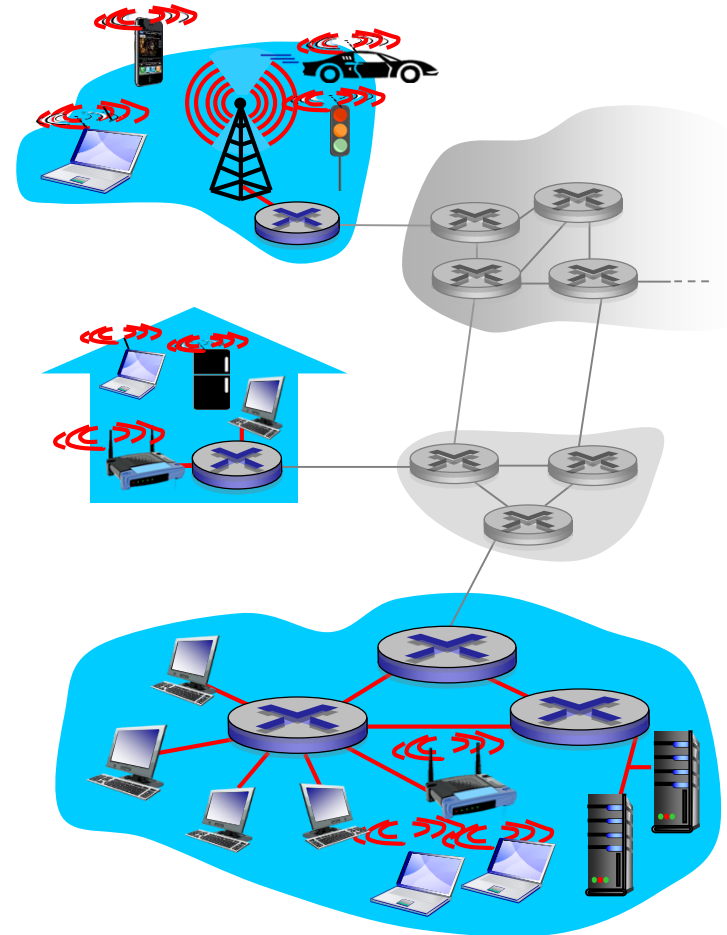

Access network: digital subscriber line (DSL)

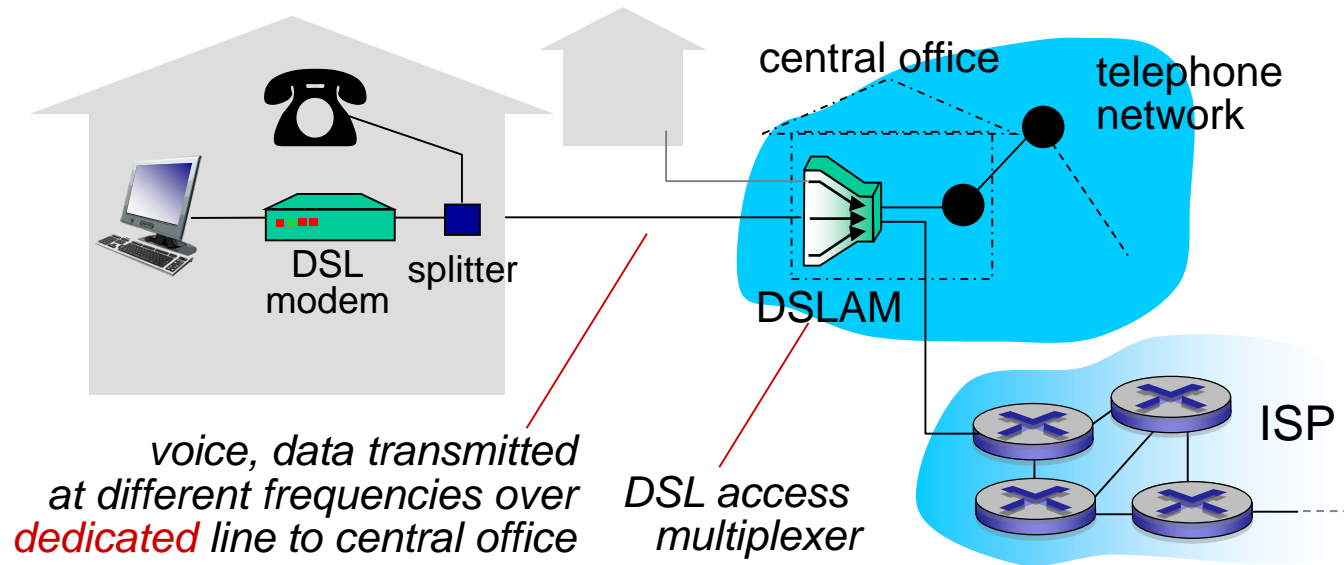

- use *existing* telephone line to central office DSLAM
 - data over DSL phone line goes to Internet
 - voice over DSL phone line goes to telephone net
- < 2.5 Mbps upstream transmission rate (typically < 1 Mbps)
- < 24 Mbps downstream transmission rate (typically < 10 Mbps)

Access network: cable network

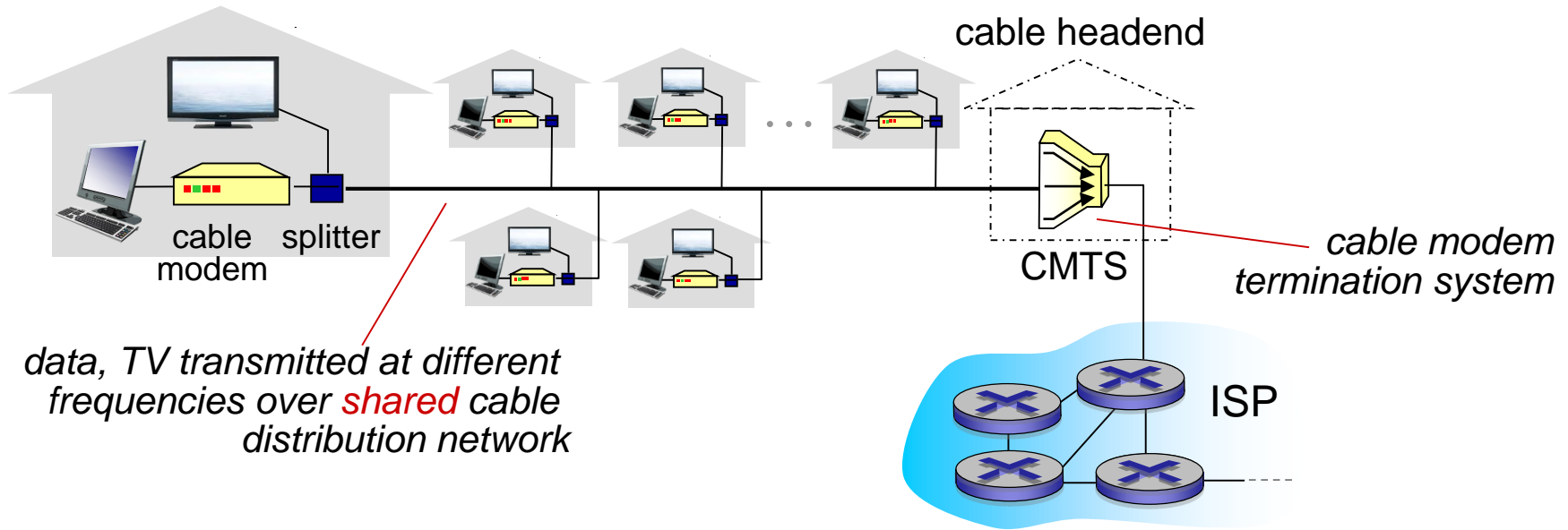

- **HFC: hybrid fiber coax**
 - asymmetric: up to 30Mbps downstream transmission rate, 2 Mbps upstream transmission rate
- **network** of cable, fiber attaches homes to ISP router
 - homes *share access network* to cable headend
 - unlike DSL, which has dedicated access to central office

Access network: home network

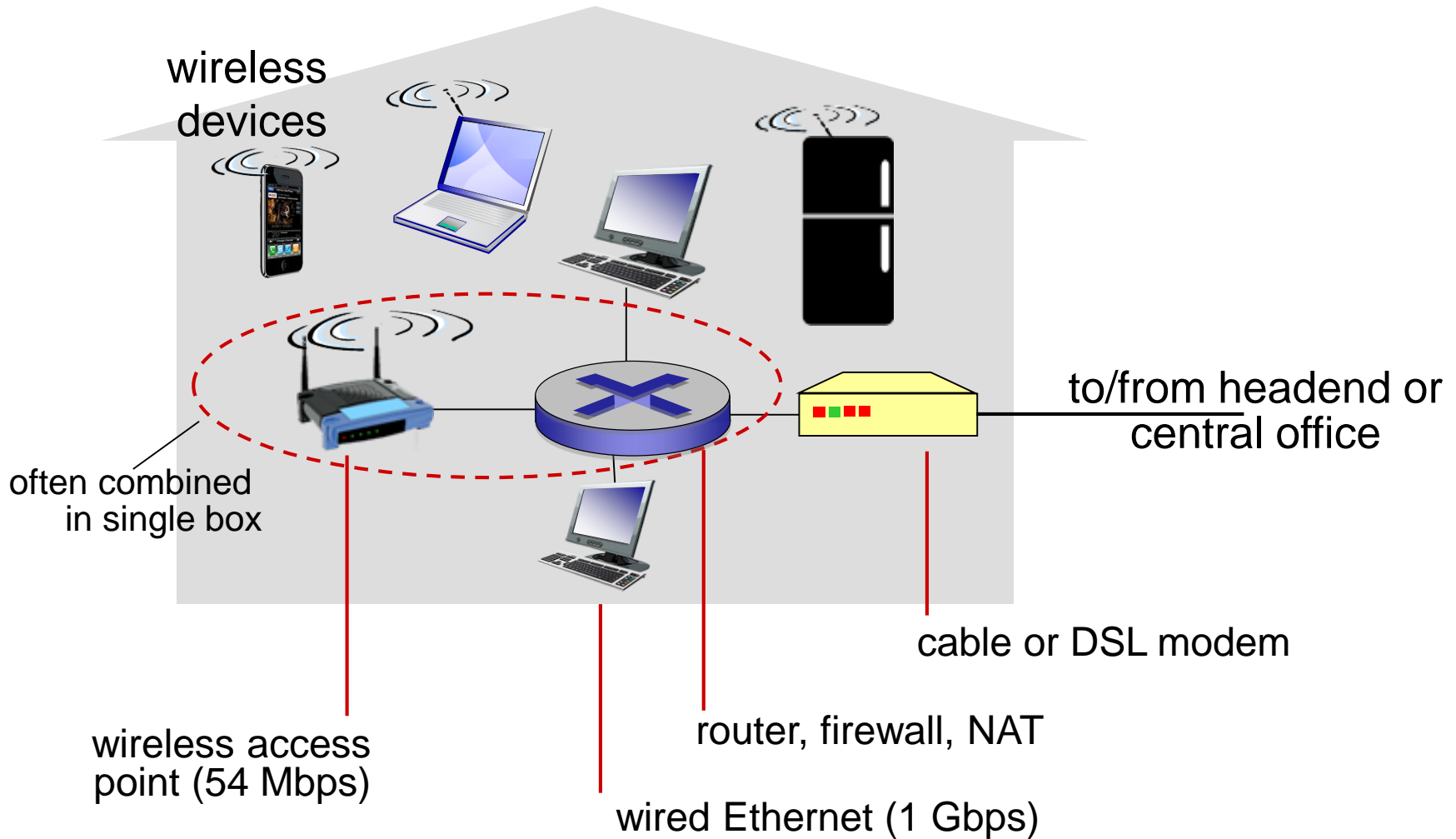

Enterprise access networks (Ethernet)

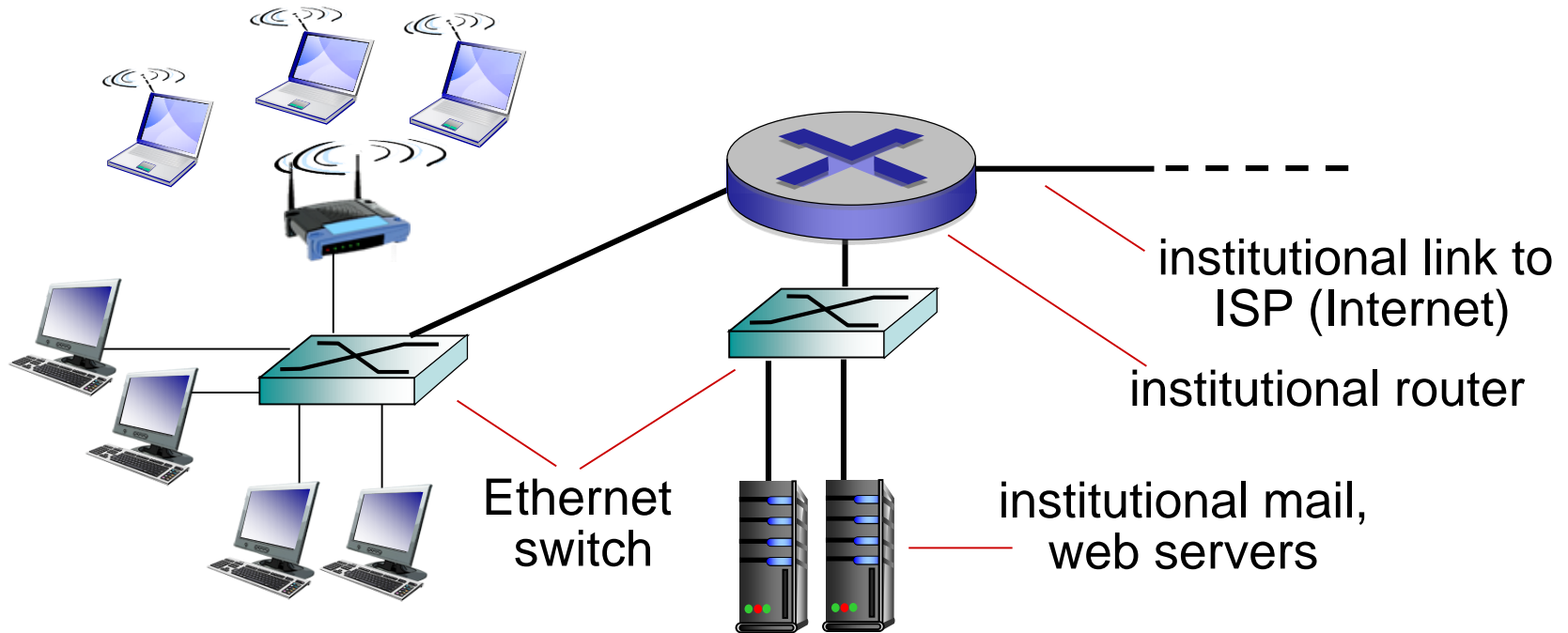

- typically used in companies, universities, etc.
- 10 Mbps, 100Mbps, 1Gbps, 10Gbps transmission rates
- today, end systems typically connect into Ethernet switch

Wireless access networks

- shared *wireless* access network connects end system to router
 - via base station aka “access point”

wireless LANs:

- within building (100 ft.)
- 802.11b/g/n (WiFi): 11, 54, 450 Mbps transmission rate

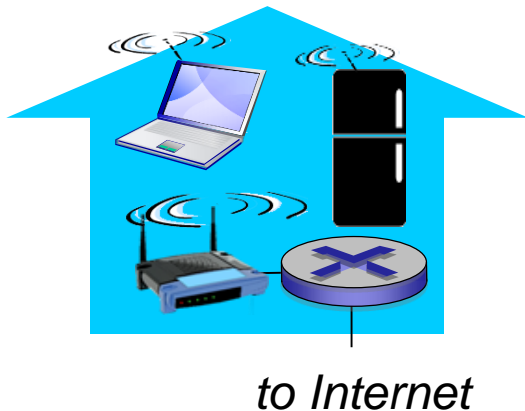

wide-area wireless access

- provided by telco (cellular) operator
10' s km
- between 1 and 10 Mbps
- 3G, 4G: LTE



Host: sends *packets* of data

host sending function:

- takes application message
- breaks into smaller chunks, known as *packets*, of length L bits
- transmits packet into access network at *transmission rate R*
 - link transmission rate, aka link *capacity*, aka *link bandwidth*

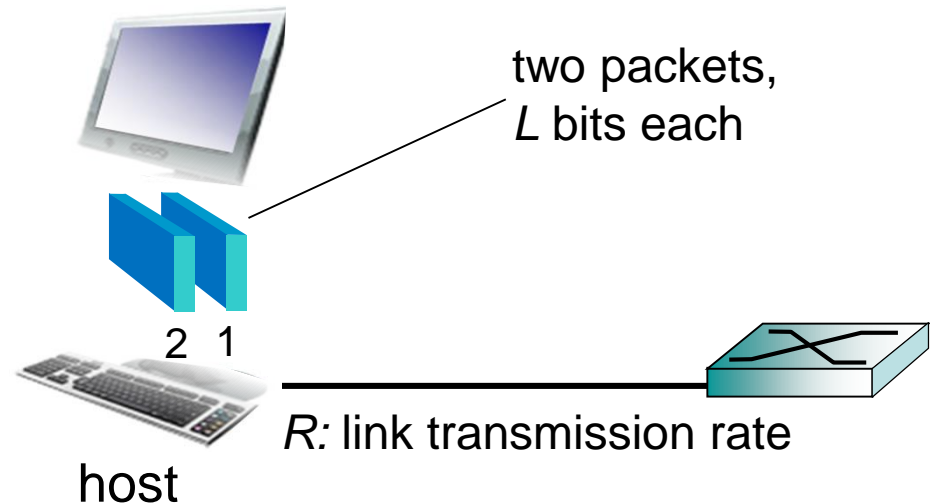

$$\text{packet transmission delay} = \text{time needed to transmit } L\text{-bit packet into link} = \frac{L \text{ (bits)}}{R \text{ (bits/sec)}}$$

Physical media

- **bit:** propagates between transmitter/receiver pairs
- **physical link:** what lies between transmitter & receiver
- **guided media:**
 - signals propagate in solid media: copper, fiber, coax
- **unguided media:**
 - signals propagate freely, e.g., radio

twisted pair (TP)

- two insulated copper wires
 - Category 5: 100 Mbps, 1 Gbps Ethernet
 - Category 6: 10Gbps



Physical media: coax, fiber

coaxial cable:

- two concentric copper conductors
- bidirectional
- broadband:
 - multiple channels on cable
 - HFC

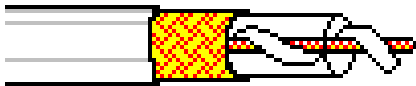

fiber optic cable:

- glass fiber carrying light pulses, each pulse a bit
- high-speed operation:
 - high-speed point-to-point transmission (e.g., 10' s-100' s Gbps transmission rate)
- low error rate:
 - repeaters spaced far apart
 - immune to electromagnetic noise



Physical media: radio

- signal carried in electromagnetic spectrum
- no physical “wire”
- bidirectional
- propagation environment effects:
 - reflection
 - obstruction by objects
 - interference

radio link types:

- **terrestrial microwave**
 - e.g. up to 45 Mbps channels
- **LAN (e.g., WiFi)**
 - 54 Mbps
- **wide-area (e.g., cellular)**
 - 4G cellular: ~ 10 Mbps
- **satellite**
 - Kbps to 45Mbps channel (or multiple smaller channels)
 - 270 msec end-end delay
 - geosynchronous versus low altitude

Chapter 1: roadmap

1.1 what is the Internet?

1.2 network edge

- end systems, access networks, links

1.3 network core

- packet switching, circuit switching, network structure

1.4 delay, loss, throughput in networks

1.5 protocol layers, service models

1.6 history

The network core

- mesh of interconnected routers
- packet-switching: hosts break application-layer messages into *packets*
 - forward packets from one router to the next, across links on path from source to destination
 - each packet transmitted at full link capacity

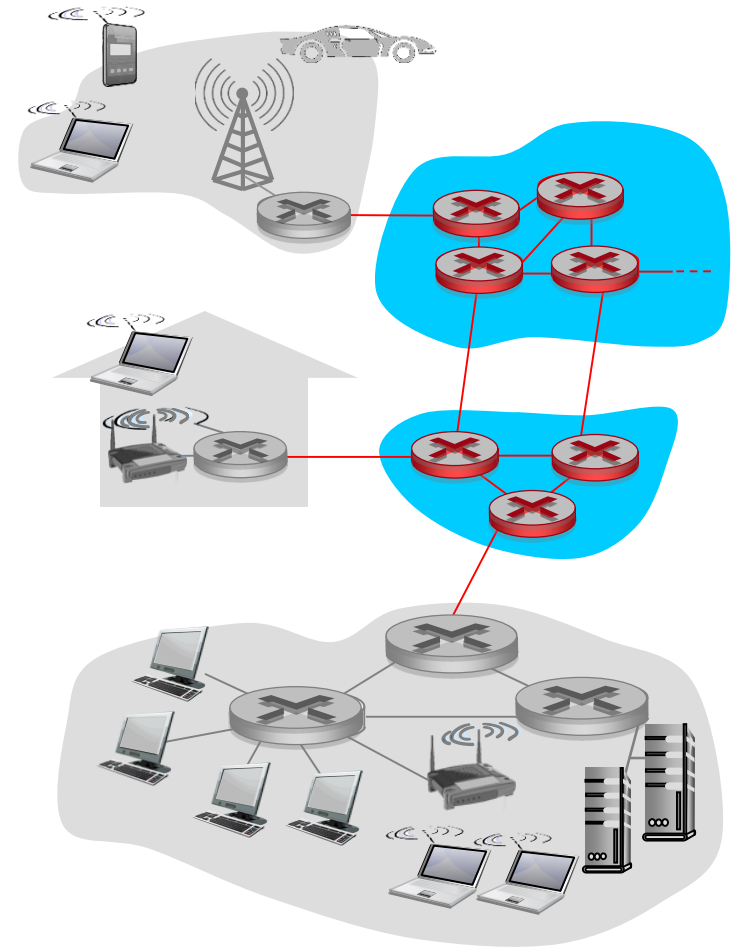

Packet-switching: store-and-forward

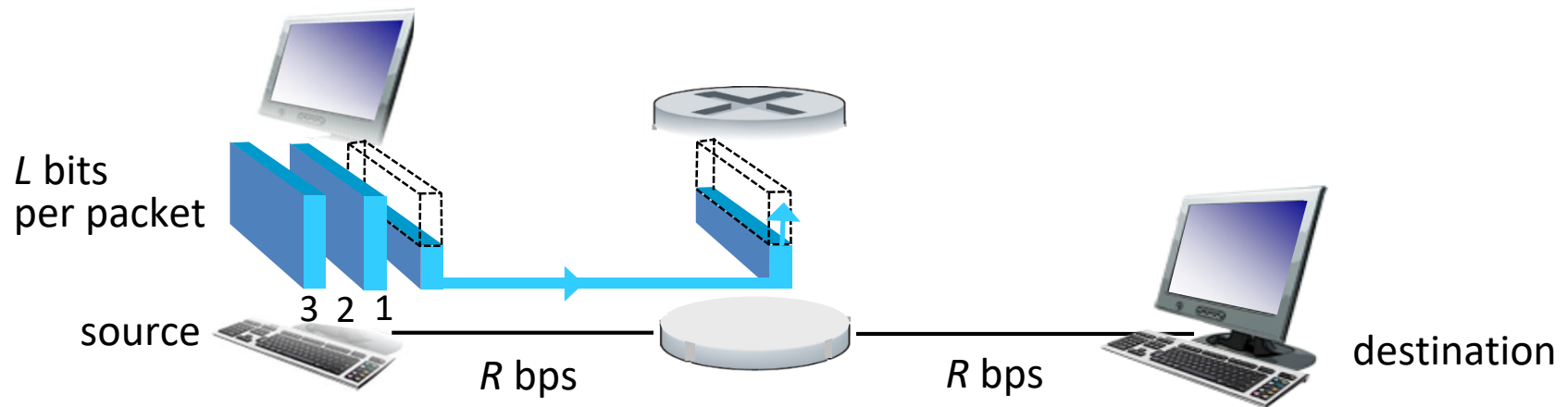

- takes L/R seconds to transmit (push out) L -bit packet into link at R bps
- *store and forward*: entire packet must arrive at router before it can be transmitted on next link
- end-end delay = $2L/R$ (assuming zero propagation delay)

one-hop numerical example:

- $L = 7.5$ Mbits
- $R = 1.5$ Mbps
- one-hop transmission delay = 5 sec

} more on delay shortly ...

Packet Switching: queueing delay, loss

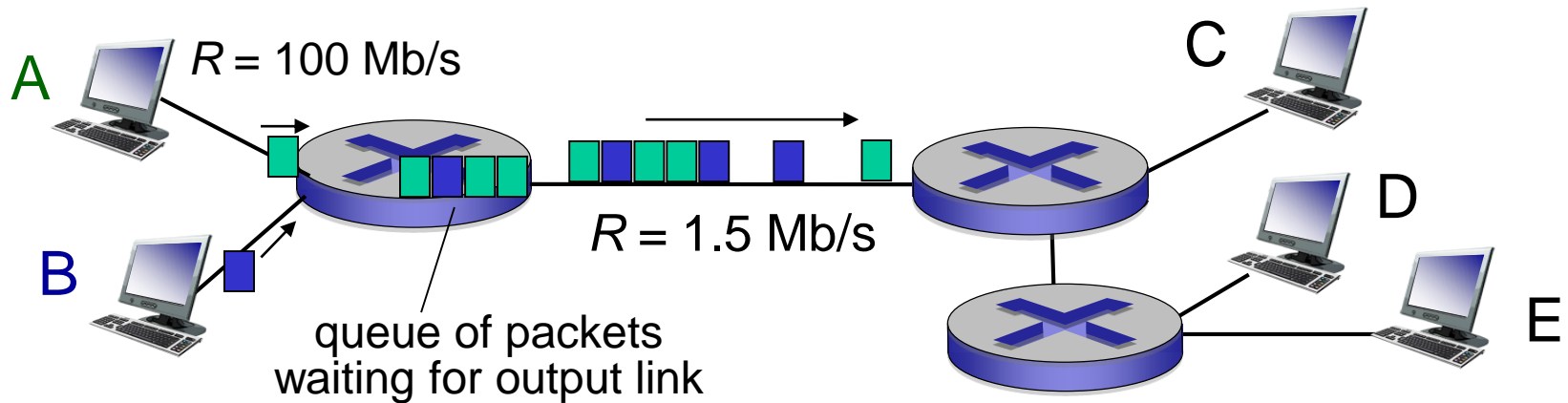

queuing and loss:

- if arrival rate (in bits) to link exceeds transmission rate of link for a period of time:
 - packets will queue, wait to be transmitted on link
 - packets can be dropped (lost) if memory (buffer) fills up

Two key network-core functions

routing: determines source-destination route taken by packets

- *routing algorithms*

forwarding: move packets from router's input to appropriate router output

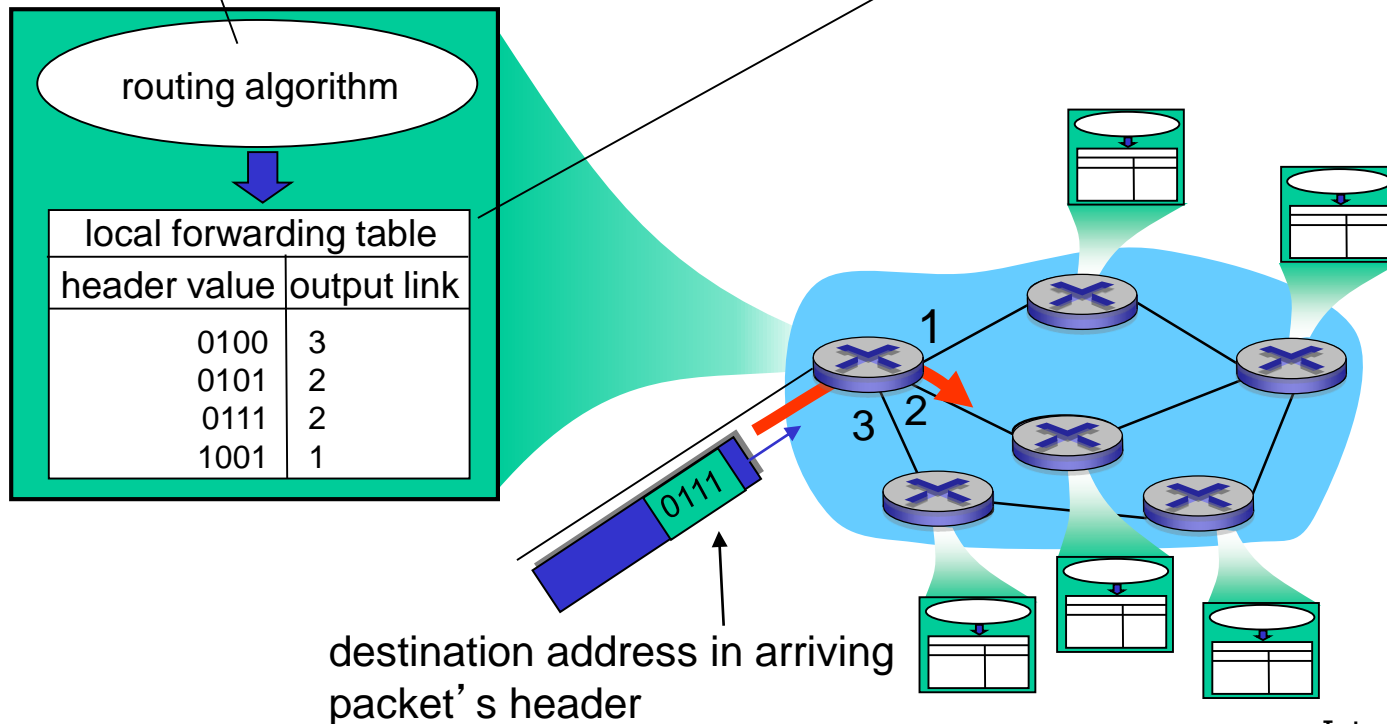

Alternative core: circuit switching

end-end resources allocated to, reserved for “call” between source & dest:

- in diagram, each link has four circuits.
 - call gets 2nd circuit in top link and 1st circuit in right link.
- dedicated resources: no sharing
 - circuit-like (guaranteed) performance
- circuit segment idle if not used by call (*no sharing*)
- commonly used in traditional telephone networks

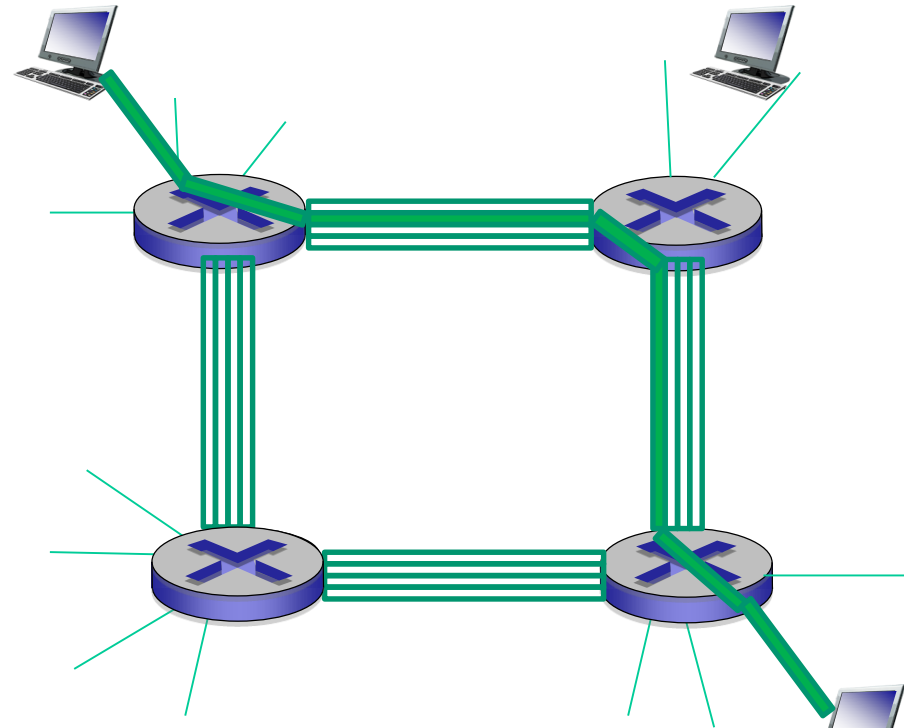

Circuit switching: FDM versus TDM

FDM

Example:

4 users

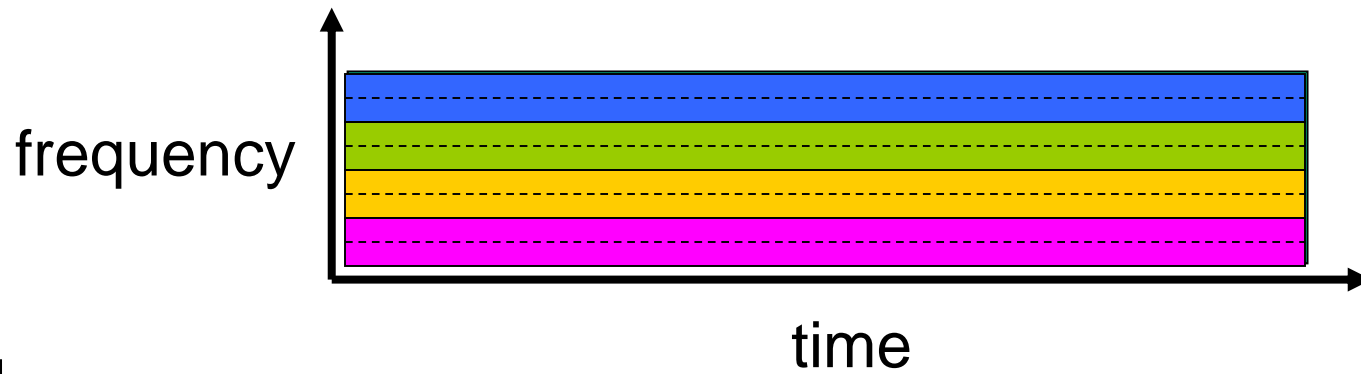

TDM

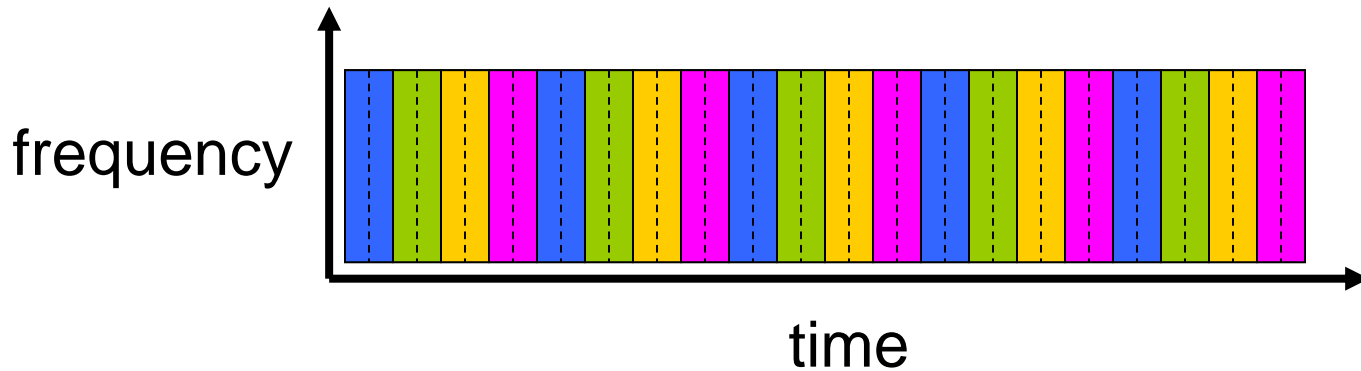

Packet switching versus circuit switching

packet switching allows more users to use network!

example:

- 1 Mb/s link
- each user:
 - 100 kb/s when “active”
 - active 10% of time
- *circuit-switching*:
 - 10 users
- *packet switching*:
 - with 35 users, probability > 10 active at same time is less than .0004 *

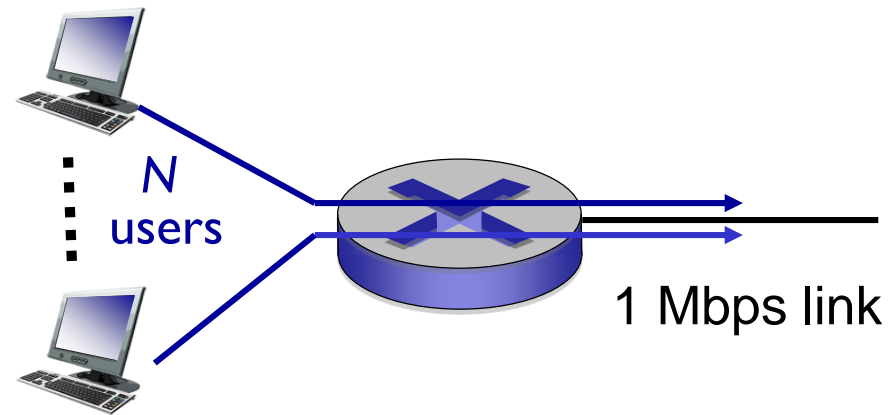

Q: how did we get value 0.0004?

Q: what happens if > 35 users ?

* Check out the online interactive exercises for more examples: http://gaia.cs.umass.edu/kurose_ross/interactive/

Packet switching versus circuit switching

is packet switching a “slam dunk winner?”

- great for bursty data
 - resource sharing
 - simpler, no call setup
- **excessive congestion possible:** packet delay and loss
 - protocols needed for reliable data transfer, congestion control
- **Q: How to provide circuit-like behavior?**
 - bandwidth guarantees needed for audio/video apps
 - still an unsolved problem (chapter 7)

Q: human analogies of reserved resources (circuit switching) versus on-demand allocation (packet-switching)?

Internet structure: network of networks

- End systems connect to Internet via **access ISPs** (Internet Service Providers)
 - residential, company and university ISPs
- Access ISPs in turn must be interconnected.
 - so that any two hosts can send packets to each other
- Resulting network of networks is very complex
 - evolution was driven by **economics** and **national policies**
- Let's take a stepwise approach to describe current Internet structure

Internet structure: network of networks

Question: given *millions* of access ISPs, how to connect them together?

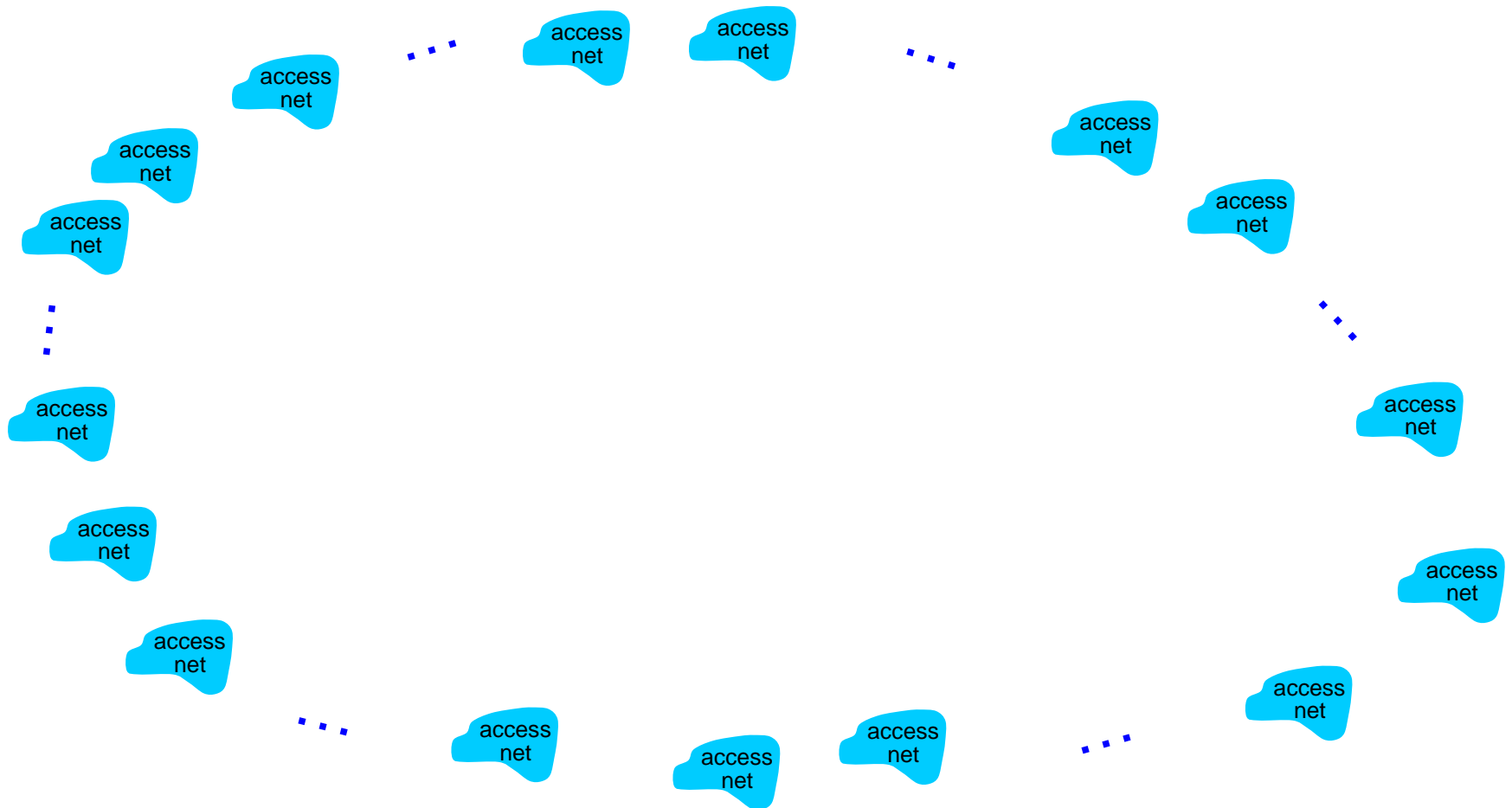

Internet structure: network of networks

Option: connect each access ISP to every other access ISP?

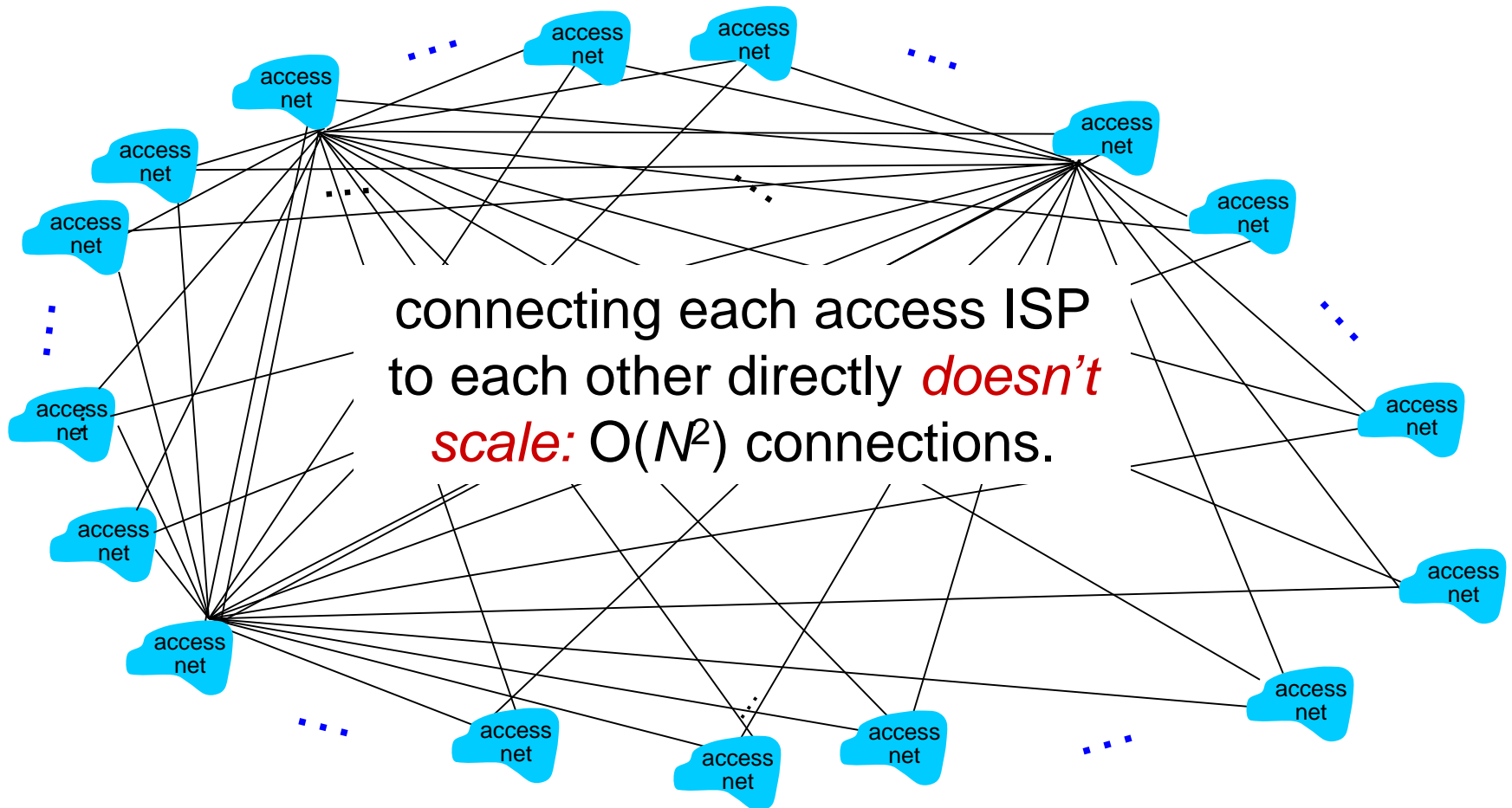

Internet structure: network of networks

Option: connect each access ISP to one global transit ISP?

Customer and *provider* ISPs have economic agreement.

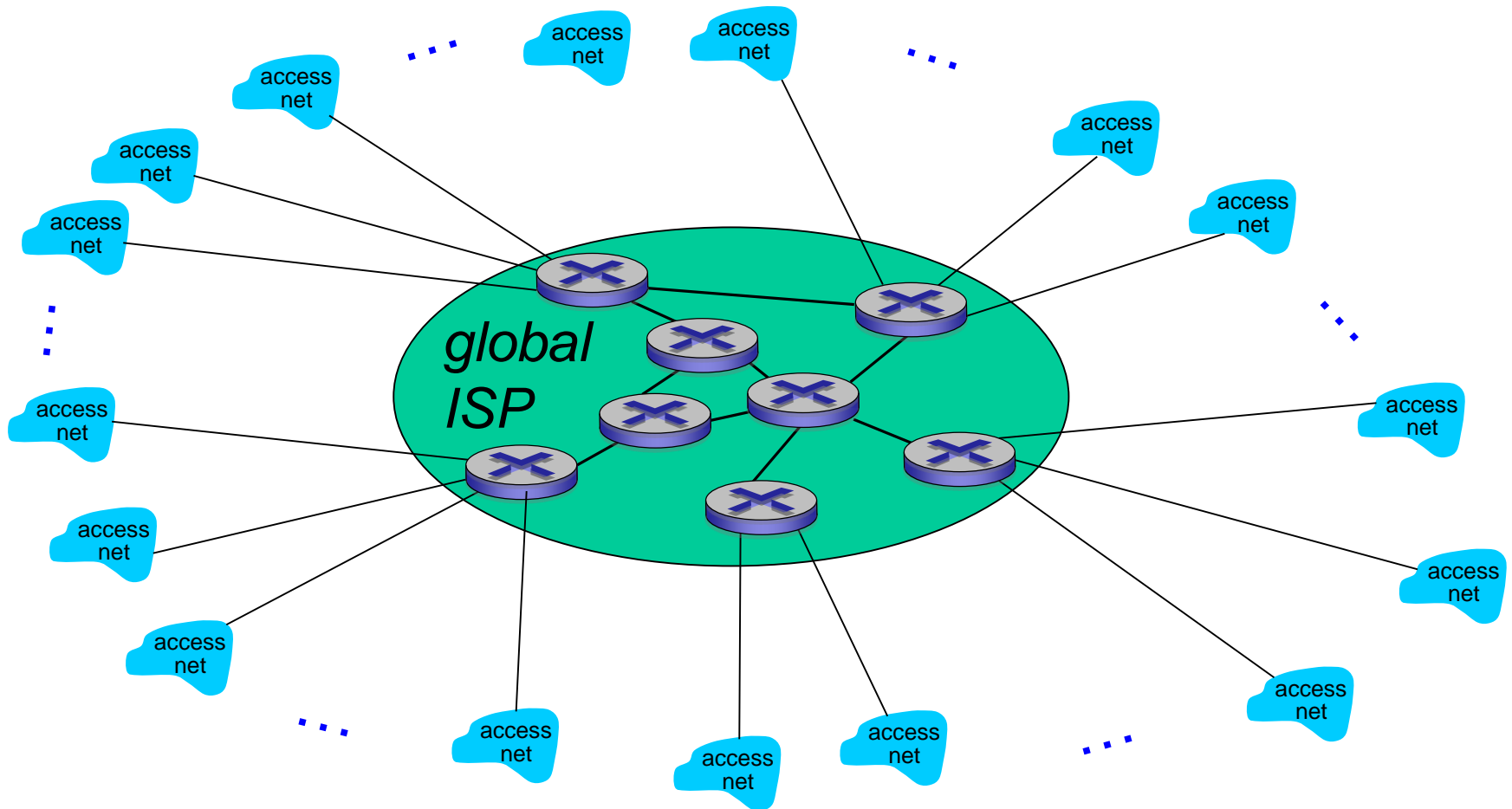

Internet structure: network of networks

But if one global ISP is viable business, there will be competitors

....

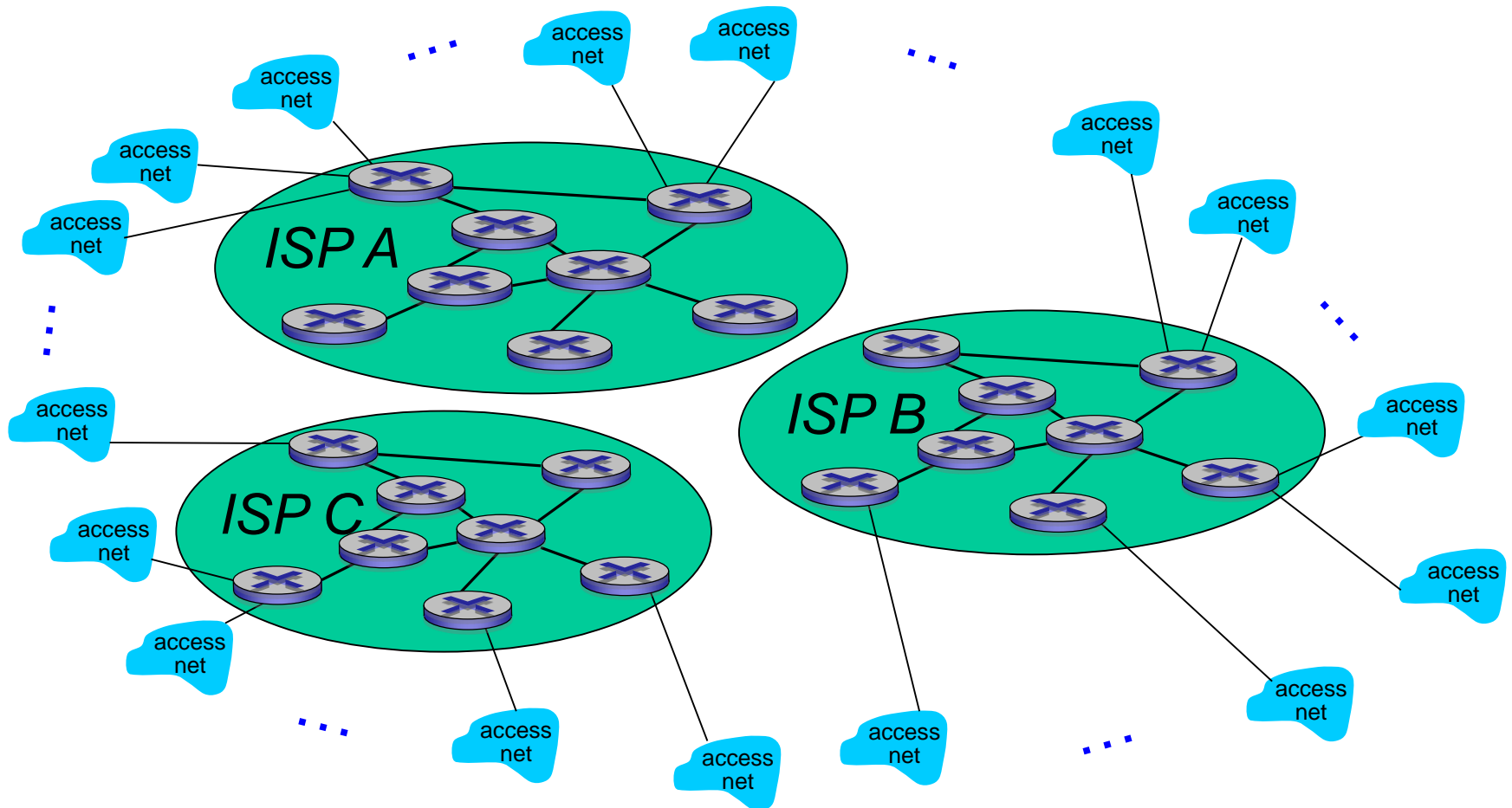

Internet structure: network of networks

But if one global ISP is viable business, there will be competitors
.... which must be interconnected

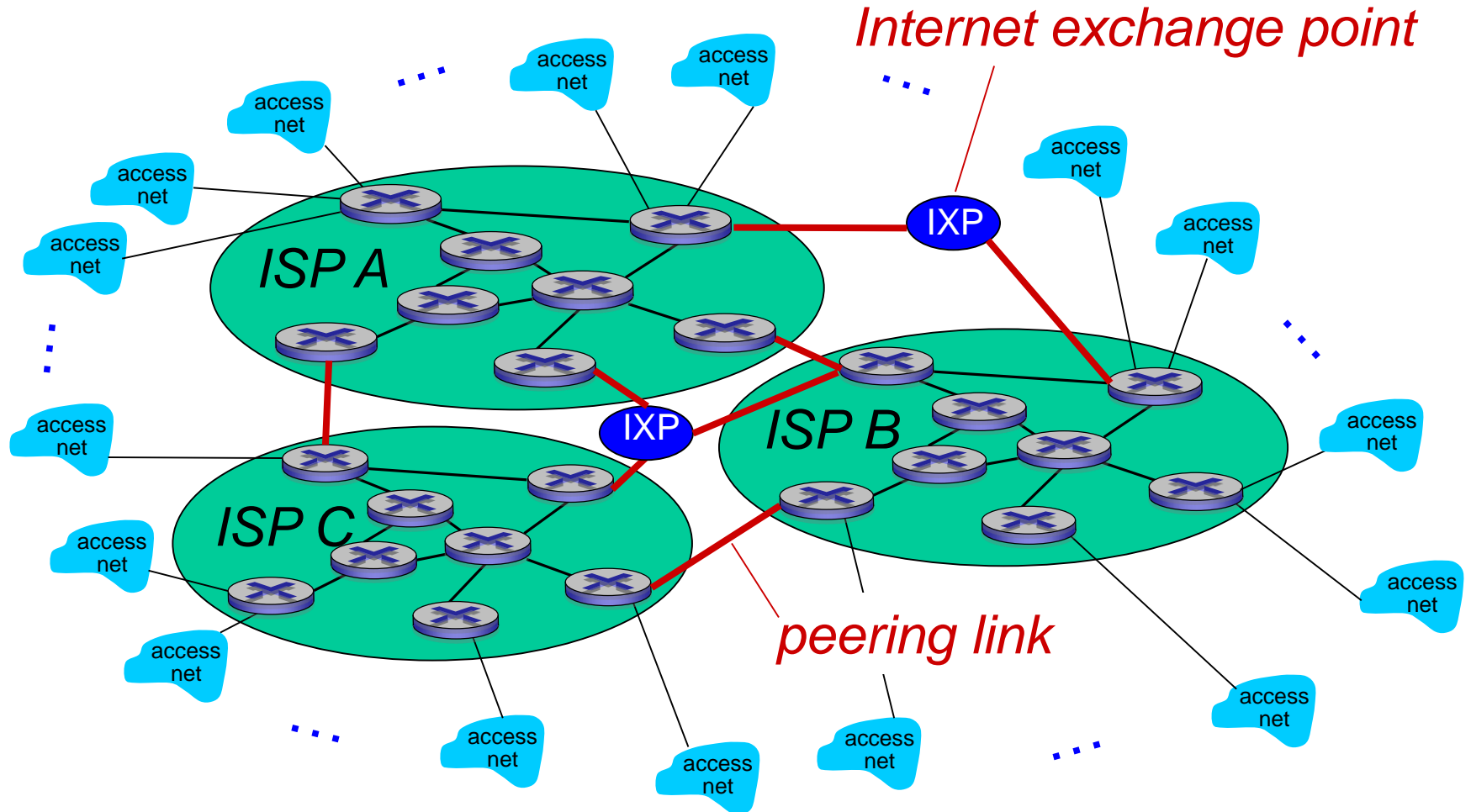

Internet structure: network of networks

... and regional networks may arise to connect access nets to ISPs

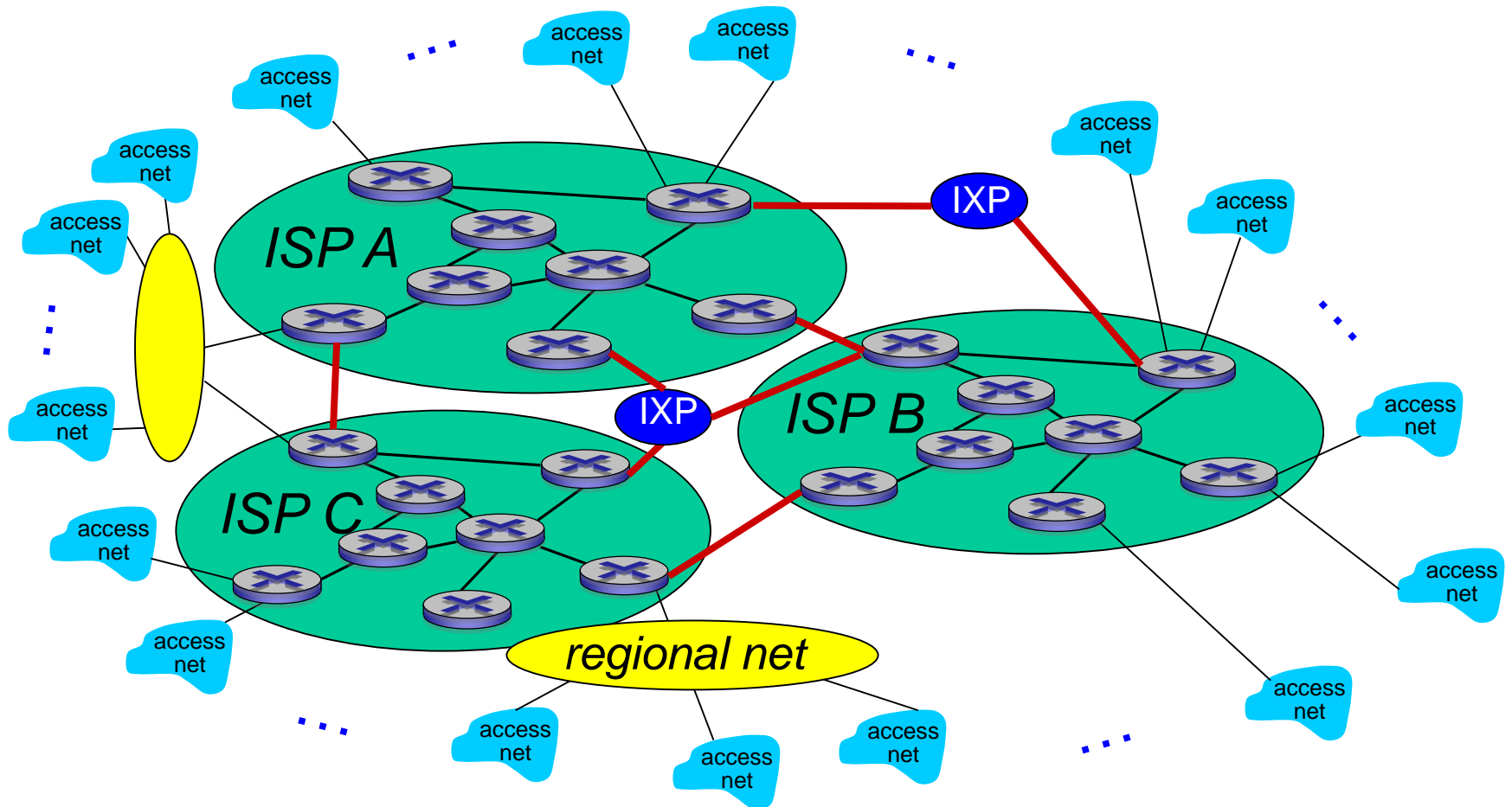

Internet structure: network of networks

... and content provider networks (e.g., Google, Microsoft, Akamai) may run their own network, to bring services, content close to end users

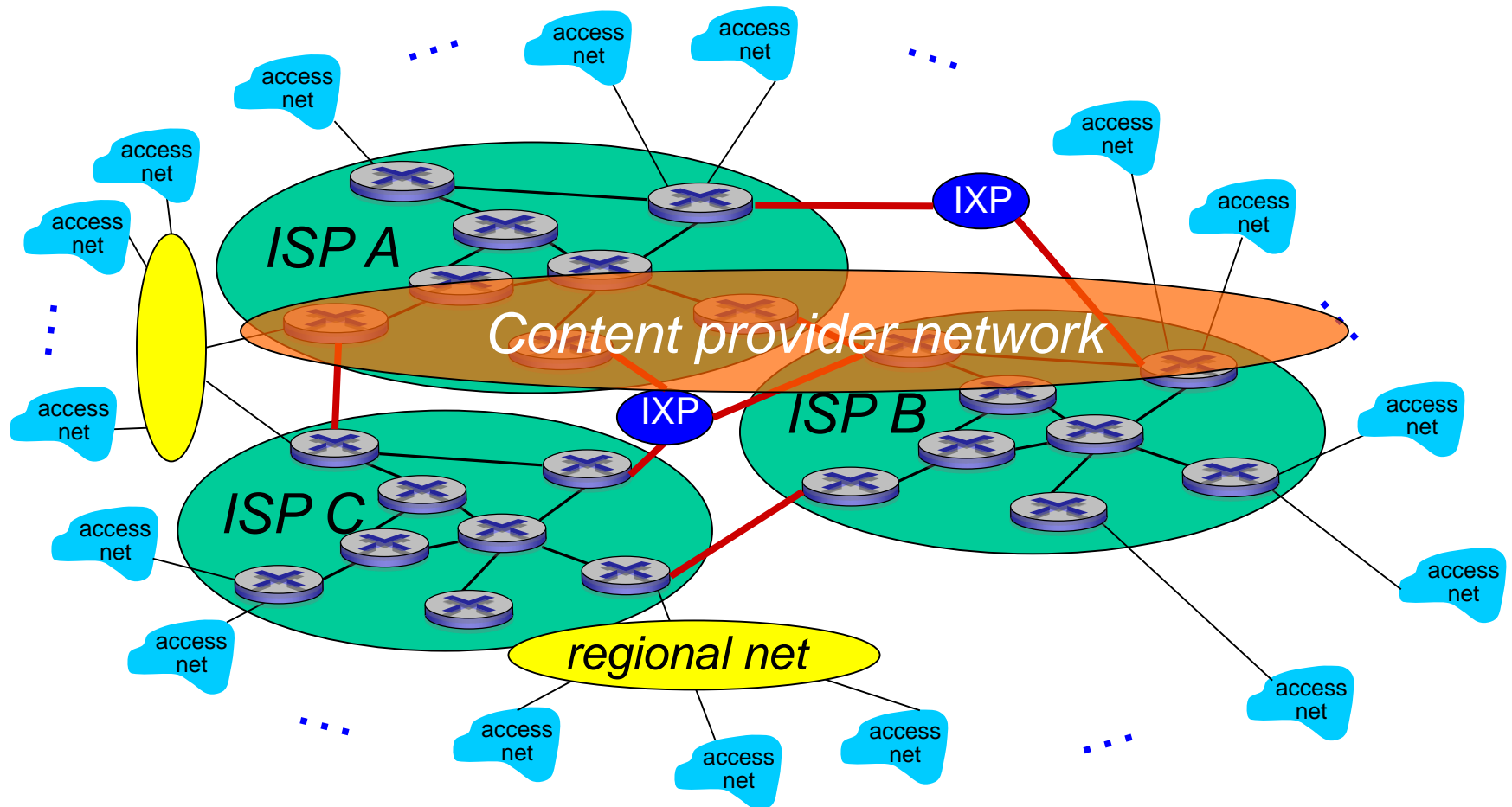

Internet structure: network of networks

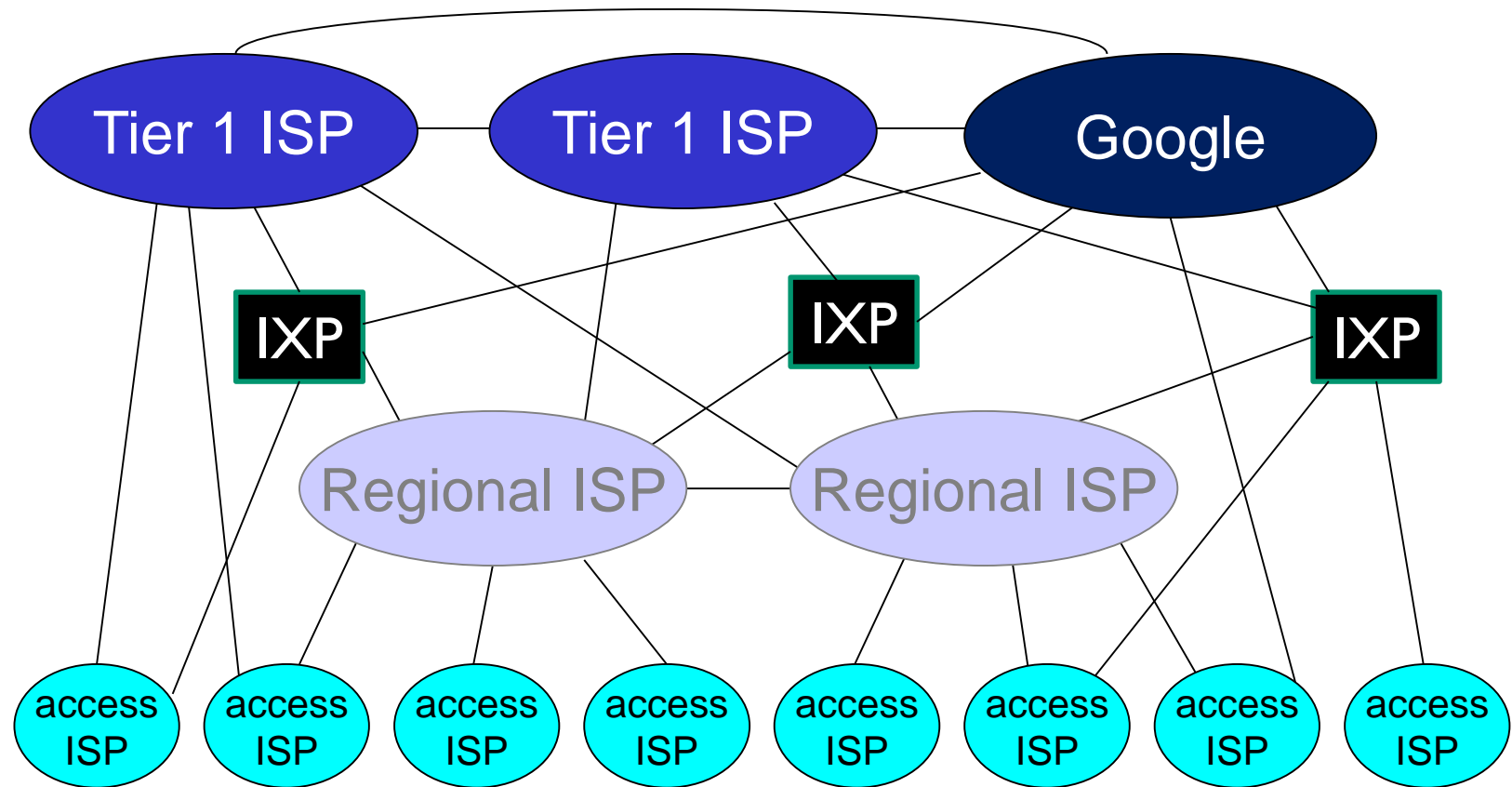

- at center: small # of well-connected large networks
 - “**tier-1**” **commercial ISPs** (e.g., Level 3, Sprint, AT&T, NTT), national & international coverage
 - **content provider network** (e.g., Google): private network that connects its data centers to Internet, often bypassing tier-1, regional ISPs

Tier-1 ISP: e.g., Sprint

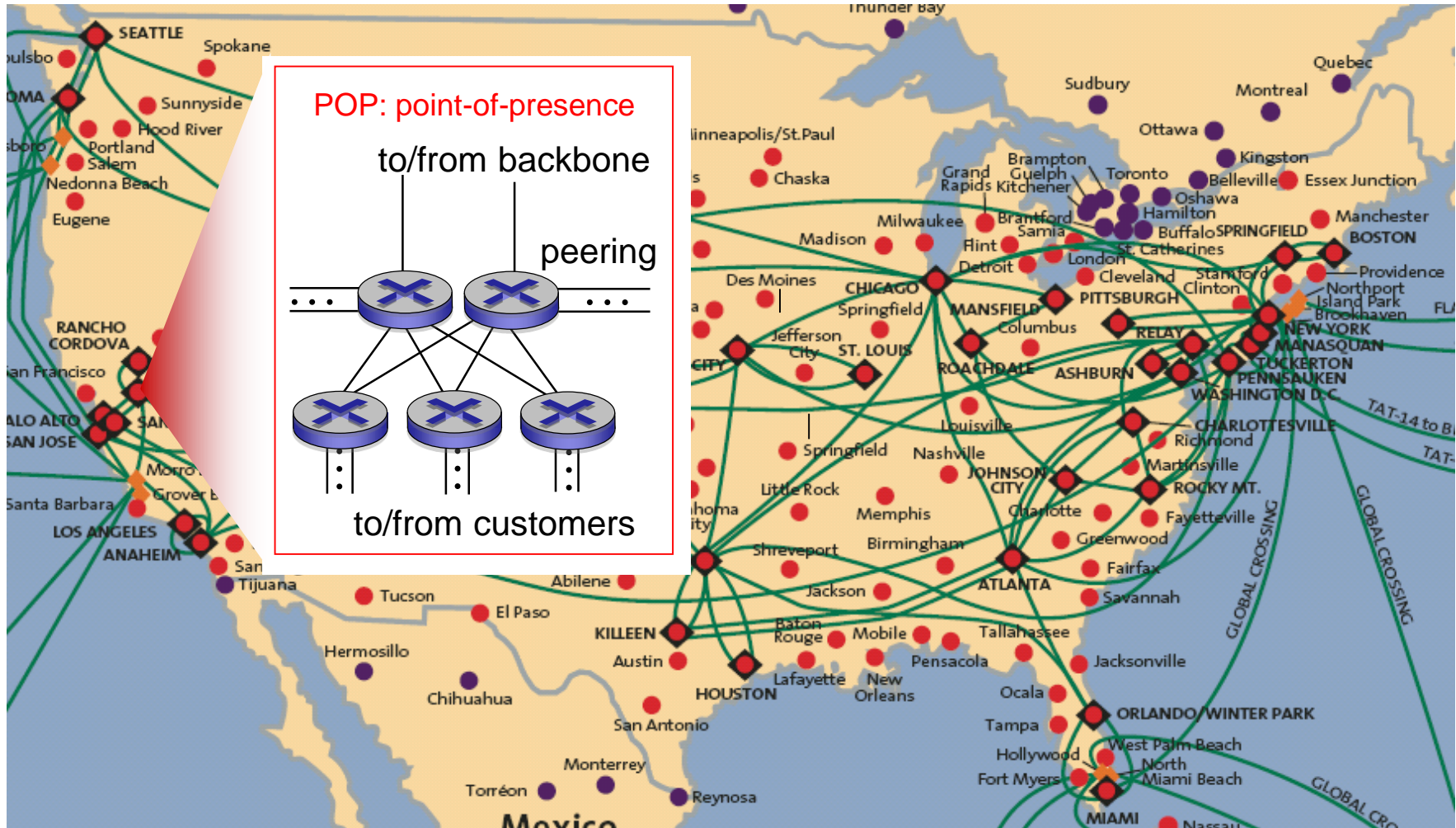

Chapter 1: roadmap

1.1 what *is* the Internet?

1.2 network edge

- end systems, access networks, links

1.3 network core

- packet switching, circuit switching, network structure

1.4 delay, loss, throughput in networks

1.5 protocol layers, service models

1.6 history

How do loss and delay occur?

packets *queue* in router buffers

- packet arrival rate to link (temporarily) exceeds output link capacity
- packets queue, wait for turn

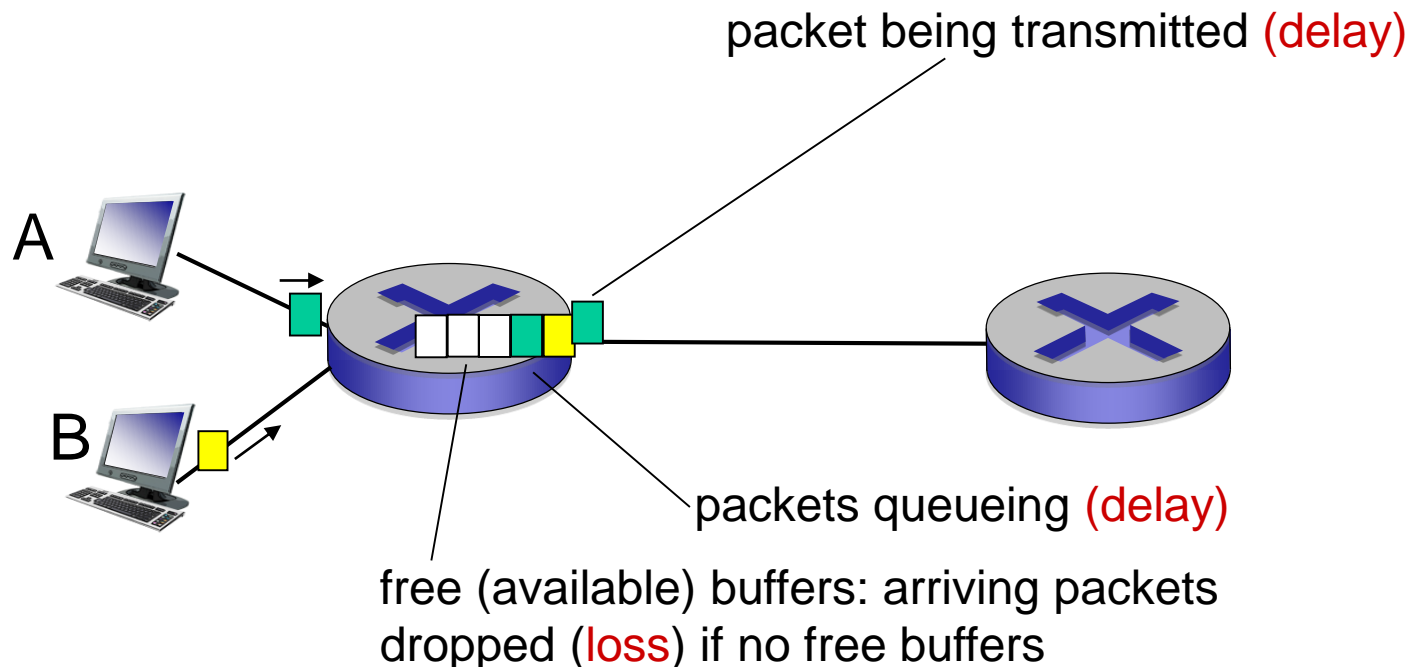

Four sources of packet delay

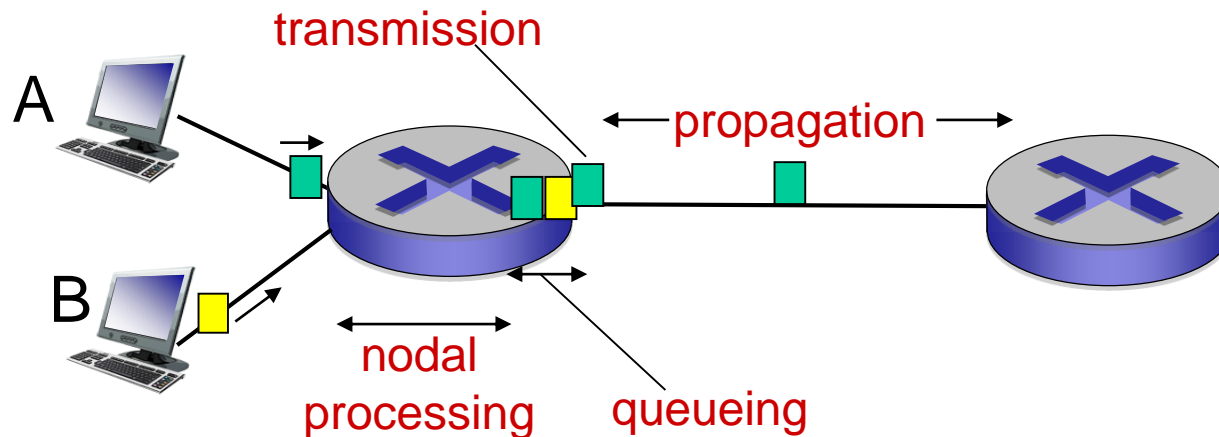

$$d_{\text{nodal}} = d_{\text{proc}} + d_{\text{queue}} + d_{\text{trans}} + d_{\text{prop}}$$

d_{proc} : nodal processing

- check bit errors
- determine output link
- typically < msec

d_{queue} : queueing delay

- time waiting at output link for transmission
- depends on congestion level of router

Four sources of packet delay

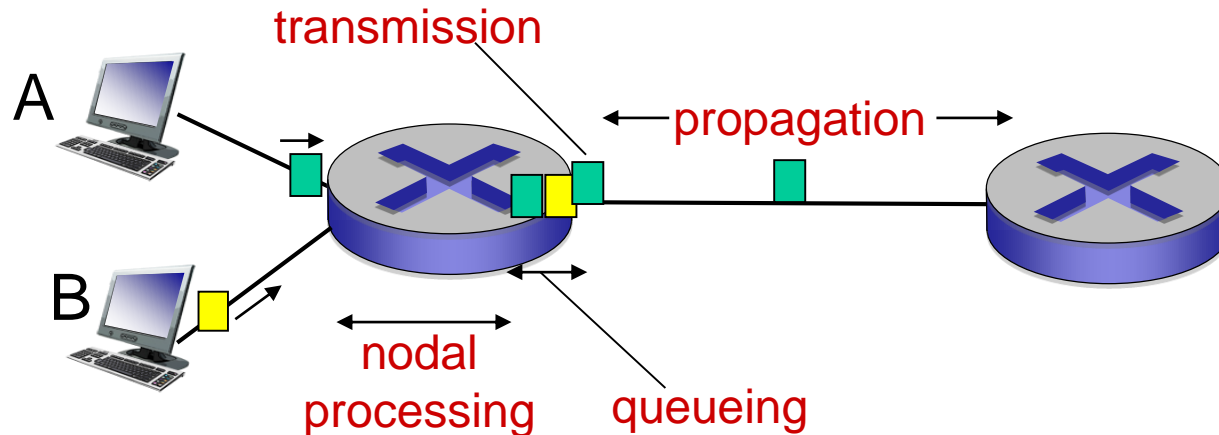

$$d_{\text{nodal}} = d_{\text{proc}} + d_{\text{queue}} + d_{\text{trans}} + d_{\text{prop}}$$

d_{trans} : transmission delay:

- L : packet length (bits)
- R : link bandwidth (bps)
- $d_{\text{trans}} = L/R$

d_{prop} : propagation delay:

- d : length of physical link
- s : propagation speed ($\sim 2 \times 10^8$ m/sec)
- $d_{\text{prop}} = d/s$

← d_{trans} and d_{prop} →
very different

* Check out the online interactive exercises for more examples: http://gaia.cs.umass.edu/kurose_ross/interactive/

* Check out the Java applet for an interactive animation on trans vs. prop delay

Caravan analogy

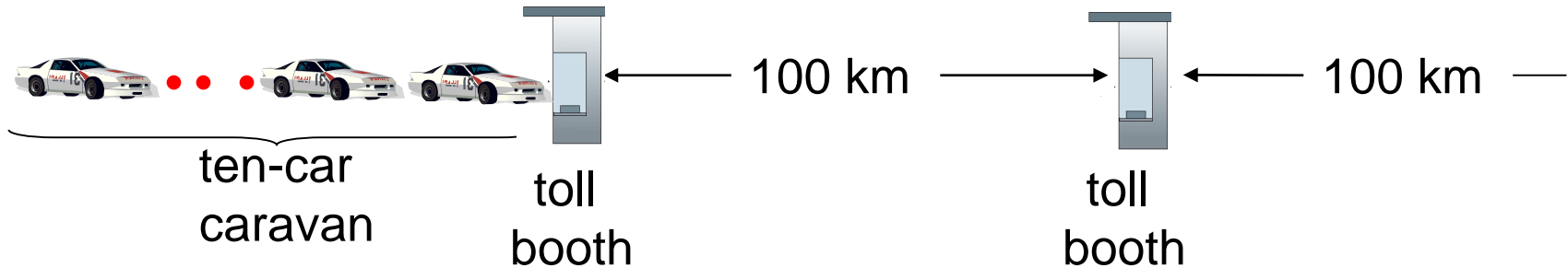

- cars “propagate” at 100 km/hr
- toll booth takes 12 sec to service car (bit transmission time)
- car ~ bit; caravan ~ packet
- **Q: How long until caravan is lined up before 2nd toll booth?**
- time to “push” entire caravan through toll booth onto highway = $12 * 10 = 120$ sec
- time for last car to propagate from 1st to 2nd toll both: $100\text{km} / (100\text{km/hr}) = 1$ hr
- **A: 62 minutes**

Caravan analogy (more)

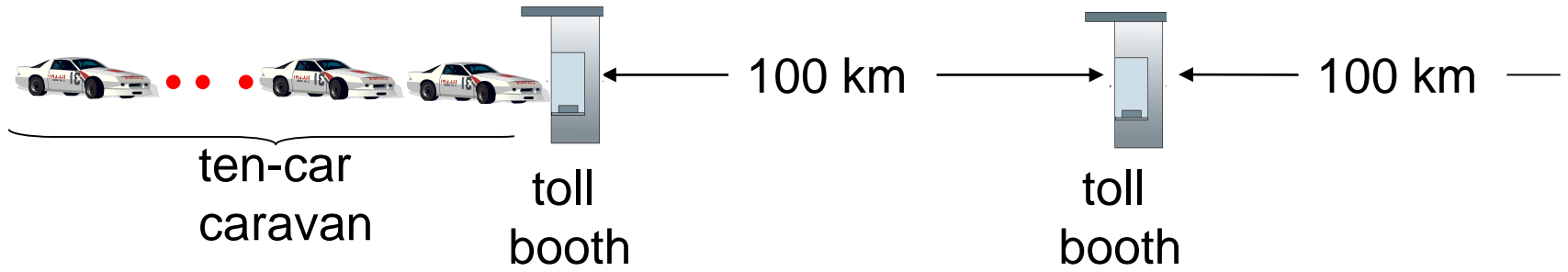

- suppose cars now “propagate” at 1000 km/hr
- and suppose toll booth now takes one min to service a car
- **Q: Will cars arrive to 2nd booth before all cars serviced at first booth?**
 - **A: Yes!** after 7 min, first car arrives at second booth; three cars still at first booth

Queueing delay (revisited)

- R : link bandwidth (bps)
- L : packet length (bits)
- a : average packet arrival rate

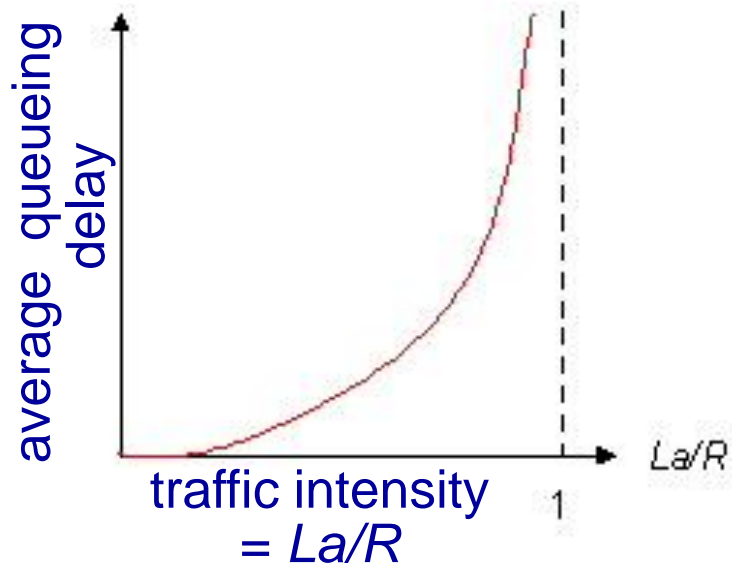

- $La/R \sim 0$: avg. queueing delay small
- $La/R \rightarrow 1$: avg. queueing delay large
- $La/R > 1$: more “work” arriving than can be serviced, average delay infinite!



$La/R \sim 0$



$La/R \rightarrow 1$

* Check online interactive animation on queuing and loss

Packet loss

- queue (aka buffer) preceding link in buffer has finite capacity
- packet arriving to full queue dropped (aka lost)
- lost packet may be retransmitted by previous node, by source end system, or not at all

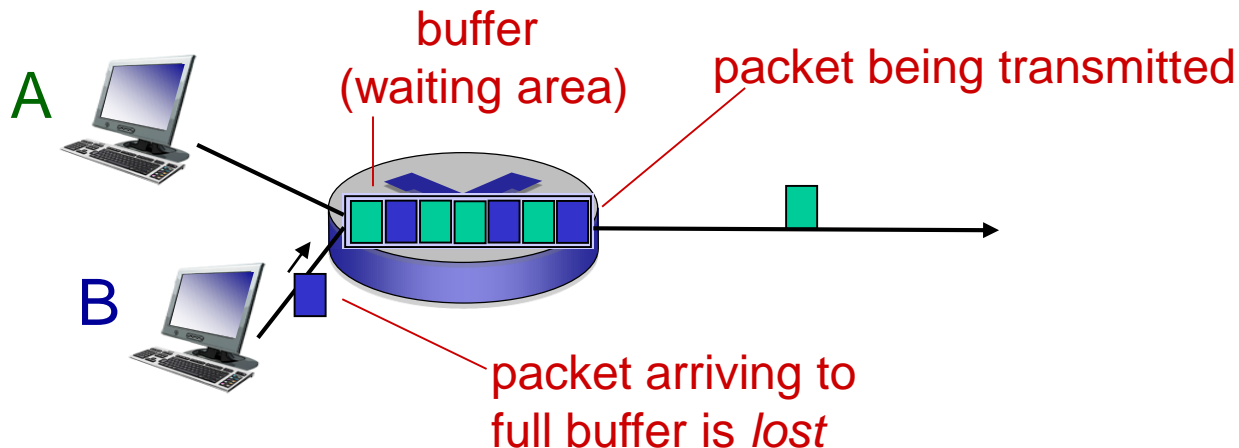

* Check out the Java applet for an interactive animation on queuing and loss

Throughput

- **throughput**: rate (bits/time unit) at which bits transferred between sender/receiver
 - **instantaneous**: rate at given point in time
 - **average**: rate over longer period of time

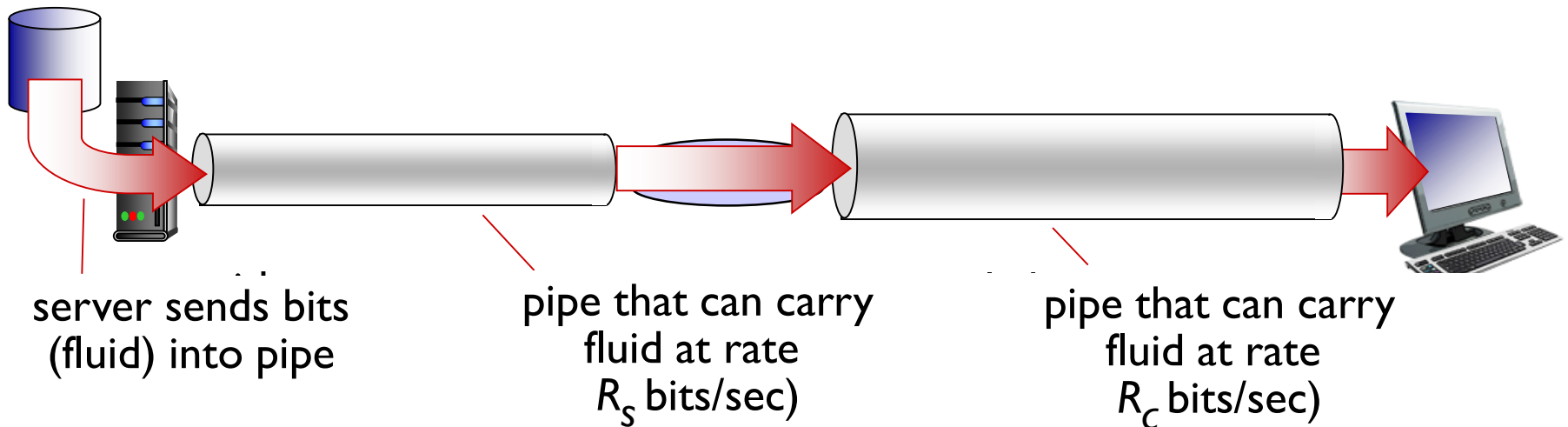

Throughput (more)

- $R_s < R_c$ What is average end-end throughput?

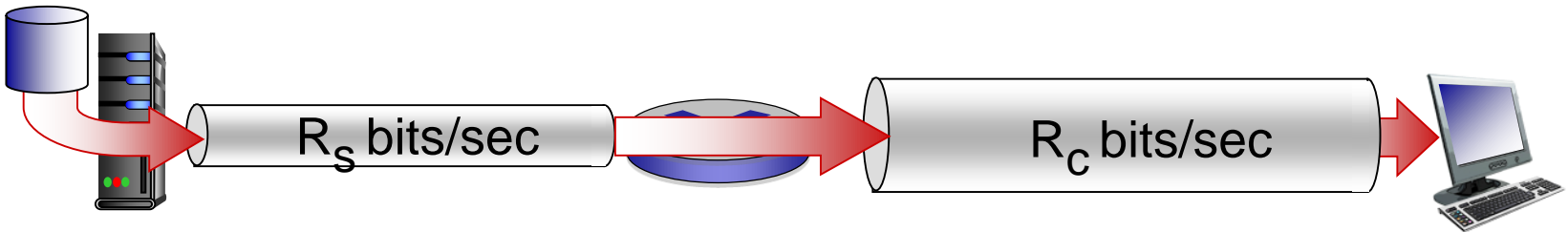

- $R_s > R_c$ What is average end-end throughput?

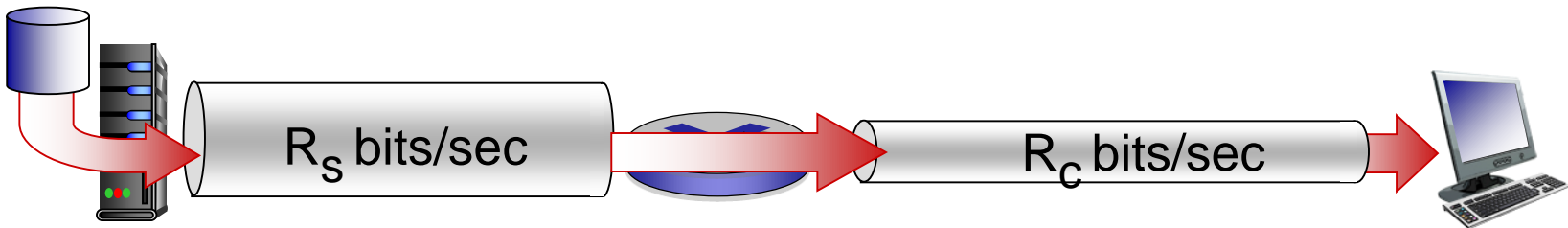

bottleneck link

link on end-end path that constrains end-end throughput

Throughput: Internet scenario

- per-connection end-end throughput:
 $\min(R_c, R_s, R/I)$
- in practice: R_c or R_s is often bottleneck

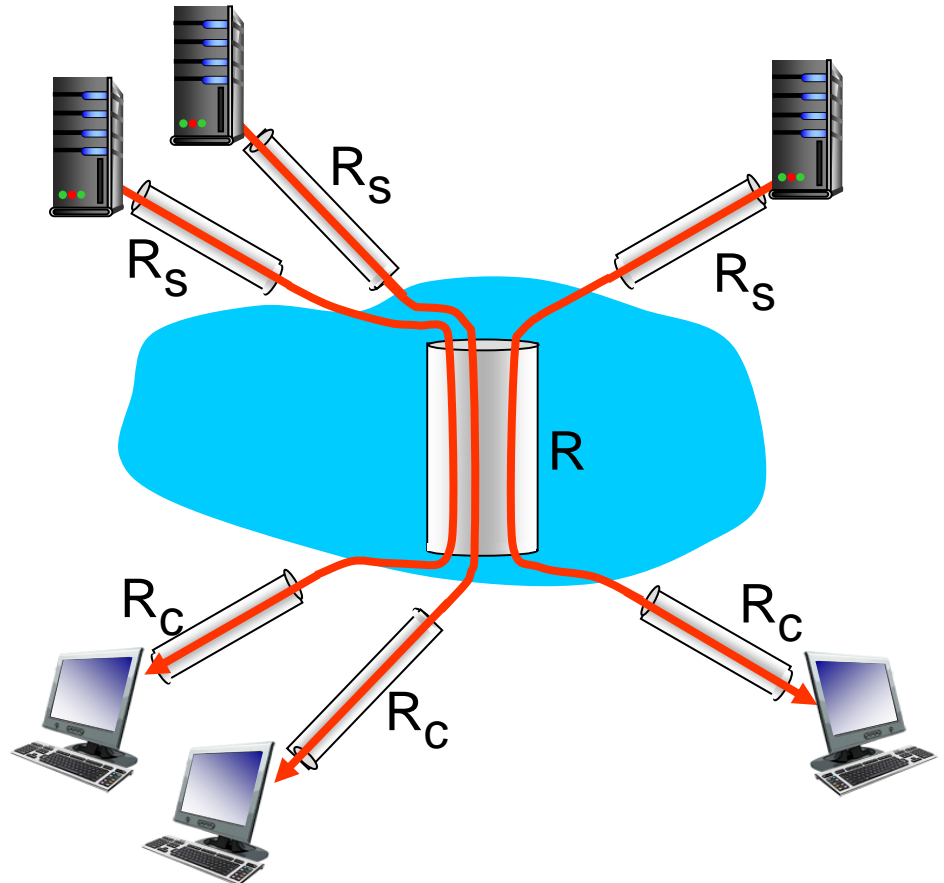

10 connections (fairly) share backbone bottleneck link R bits/sec

* Check out the online interactive exercises for more examples: http://gaia.cs.umass.edu/kurose_ross/interactive/

Chapter 1: roadmap

1.1 what *is* the Internet?

1.2 network edge

- end systems, access networks, links

1.3 network core

- packet switching, circuit switching, network structure

1.4 delay, loss, throughput in networks

1.5 protocol layers, service models

1.6 history

Protocol “layers”

*Networks are complex,
with many “pieces”:*

- hosts
- routers
- links of various media
- applications
- protocols
- hardware, software

Question:

is there any hope of
organizing structure of
network?

.... or at least our
discussion of networks?

Organization of air travel

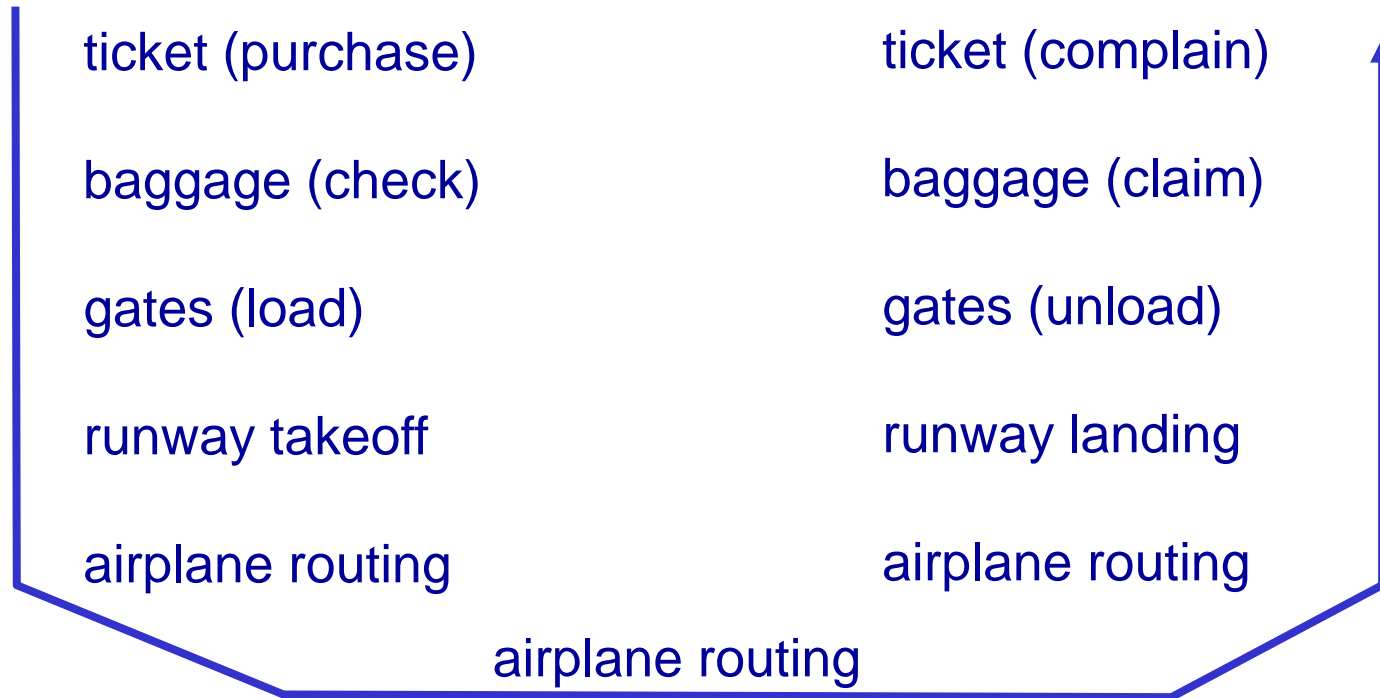

- a series of steps

Layering of airline functionality

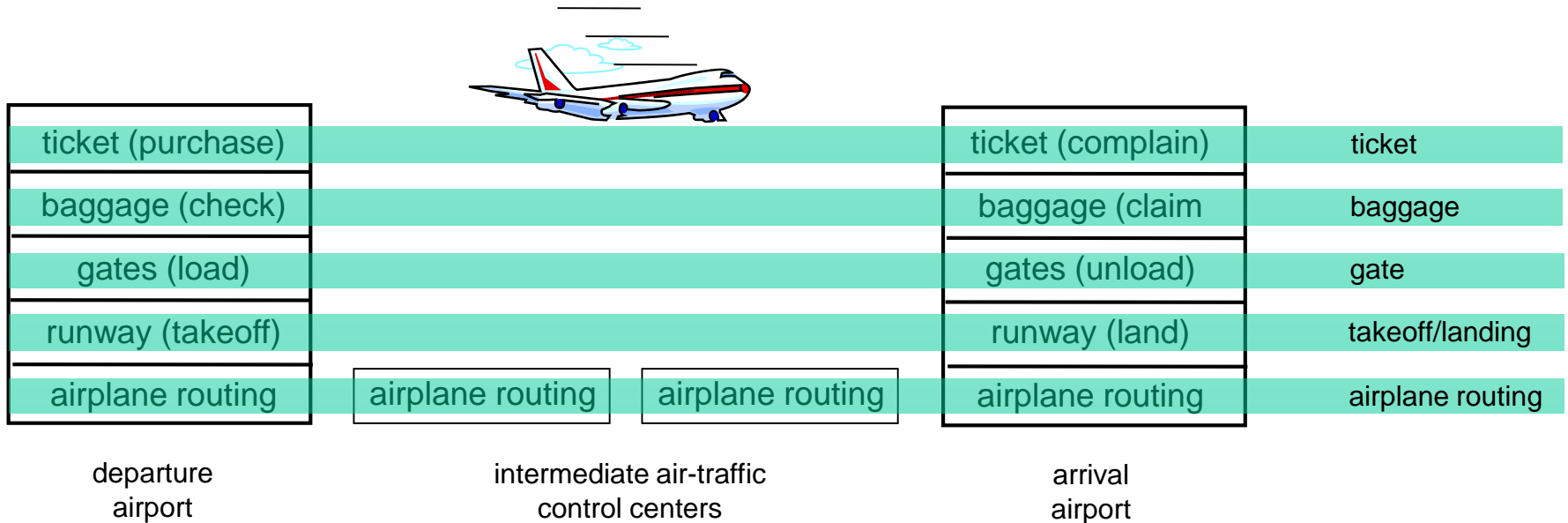

layers: each layer implements a service

- via its own internal-layer actions
- relying on services provided by layer below

Why layering?

dealing with complex systems:

- explicit structure allows identification, relationship of complex system's pieces
 - layered *reference model* for discussion
- modularization eases maintenance, updating of system
 - change of implementation of layer's service transparent to rest of system
 - e.g., change in gate procedure doesn't affect rest of system
- layering considered harmful?

Internet protocol stack

- **application:** supporting network applications
 - FTP, SMTP, HTTP
- **transport:** process-process data transfer
 - TCP, UDP
- **network:** routing of datagrams from source to destination
 - IP, routing protocols
- **link:** data transfer between neighboring network elements
 - Ethernet, 802.111 (WiFi), PPP
- **physical:** bits “on the wire”

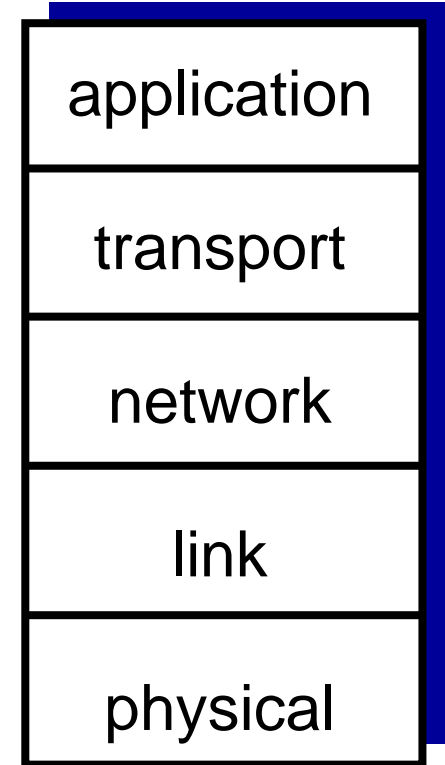

ISO/OSI reference model

- **presentation:** allow applications to interpret meaning of data, e.g., encryption, compression, machine-specific conventions
- **session:** synchronization, checkpointing, recovery of data exchange
- Internet stack “missing” these layers!
 - these services, *if needed*, must be implemented in application
 - needed?

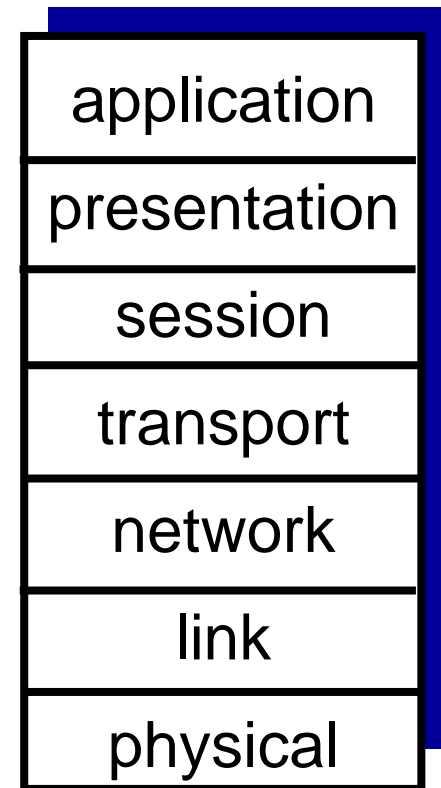

Encapsulation

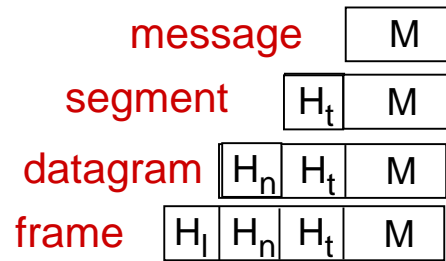

source

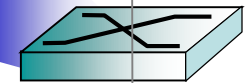
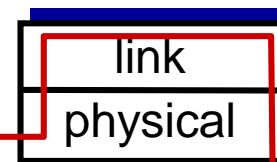
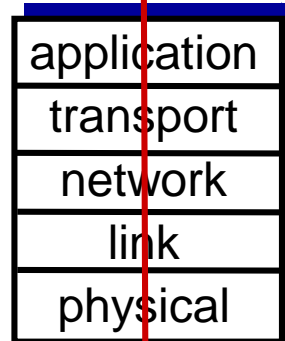

switch

destination

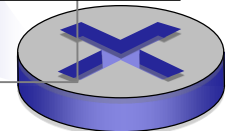
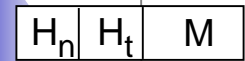
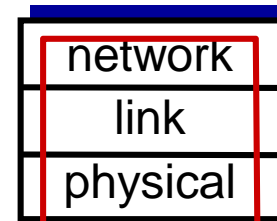
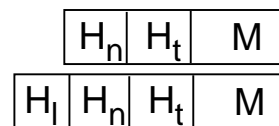
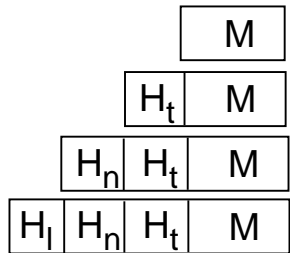
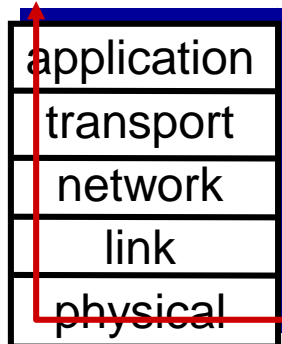

router

Chapter 1: roadmap

1.1 what *is* the Internet?

1.2 network edge

- end systems, access networks, links

1.3 network core

- packet switching, circuit switching, network structure

1.4 delay, loss, throughput in networks

1.5 protocol layers, service models

1.6 *history*

Internet history

1961-1972: Early packet-switching principles

- **1961:** Kleinrock - queueing theory shows effectiveness of packet-switching
- **1964:** Baran - packet-switching in military nets
- **1967:** ARPAnet conceived by Advanced Research Projects Agency
- **1969:** first ARPAnet node operational
- **1972:**
 - ARPAnet public demo
 - NCP (Network Control Protocol) first host-host protocol
 - first e-mail program
 - ARPAnet has 15 nodes

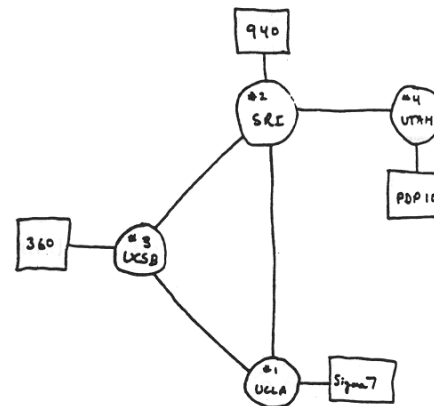

THE ARPA NETWORK

Internet history

1972-1980: Internetworking, new and proprietary nets

- **1970:** ALOHAnet satellite network in Hawaii
- **1974:** Cerf and Kahn - architecture for interconnecting networks
- **1976:** Ethernet at Xerox PARC
- **late70' s:** proprietary architectures: DECnet, SNA, XNA
- **late 70' s:** switching fixed length packets (ATM precursor)
- **1979:** ARPAnet has 200 nodes

Cerf and Kahn' s internetworking principles:

- minimalism, autonomy - no internal changes required to interconnect networks
- best effort service model
- stateless routers
- decentralized control

define today' s Internet
architecture

Internet history

1980-1990: new protocols, a proliferation of networks

- **1983:** deployment of TCP/IP
- **1982:** smtp e-mail protocol defined
- **1983:** DNS defined for name-to-IP-address translation
- **1985:** ftp protocol defined
- **1988:** TCP congestion control
- new national networks: CSnet, BITnet, NSFnet, Minitel
- 100,000 hosts connected to confederation of networks

Internet history

1990, 2000 's: commercialization, the Web, new apps

- early 1990' s: ARPAnet decommissioned
- 1991: NSF lifts restrictions on commercial use of NSFnet (decommissioned, 1995)
- early 1990s: Web
 - hypertext [Bush 1945, Nelson 1960' s]
 - HTML, HTTP: Berners-Lee
 - 1994: Mosaic, later Netscape
 - late 1990' s: commercialization of the Web
- late 1990' s – 2000' s:
 - more killer apps: instant messaging, P2P file sharing
 - network security to forefront
 - est. 50 million host, 100 million+ users
 - backbone links running at Gbps

Internet history

2005-present

- ~5B devices attached to Internet (2016)
 - smartphones and tablets
- aggressive deployment of broadband access
- increasing ubiquity of high-speed wireless access
- emergence of online social networks:
 - Facebook: ~ one billion users
- service providers (Google, Microsoft) create their own networks
 - bypass Internet, providing “instantaneous” access to search, video content, email, etc.
- e-commerce, universities, enterprises running their services in “cloud” (e.g., Amazon EC2)

Introduction: summary

covered a “ton” of material!

- Internet overview
- what’s a protocol?
- network edge, core, access network
 - packet-switching versus circuit-switching
 - Internet structure
- performance: loss, delay, throughput
- layering, service models
- history

you now have:

- context, overview, “feel” of networking
- more depth, detail *to follow!*